

2019年滾水聯盟盃全國羽球公開賽

場次時間對照表

108年3月1日(五)

地點：滾水羽球燕巢館

Court 1 ~ Court 10										
08:30	女雙Under-15[1]	男單Under-13[1]	男單Under-13[2]	男單Under-13[3]	男單Under-13[4]	男單Under-13[5]	男單Under-13[6]	男單Under-13[7]	男單Under-13[8]	男單Under-13[9]
08:45	男單Under-13[10]	男單Under-13[11]	男單Under-13[12]	男單Under-13[13]	男單Under-13[14]	男單Under-13[15]	男單Under-13[16]	男單Under-13[17]	男單Under-13[18]	男單Under-13[19]
09:00	男單Under-13[20]	男單Under-13[21]	男單Under-13[22]	男單Under-13[23]	男單Under-13[24]	男單Under-13[25]	男單Under-13[26]	男單Under-13[27]	男單Under-13[28]	男單Under-13[29]
09:15	女雙Under-15[2]	男單Under-13[30]	男單Under-13[31]	男單Under-13[32]	男單Under-13[33]	男單Under-13[34]	男單Under-13[35]	男單Under-13[36]	男單Under-13[37]	男單Under-13[38]
09:30	男單Under-13[39]	男單Under-13[40]	男單Under-13[41]	男單Under-13[42]	男單Under-13[43]	男單Under-13[44]	男單Under-13[45]	男單Under-13[46]	男單Under-13[47]	男單Under-13[48]
09:45	男單Under-13[49]	男單Under-13[50]	男單Under-13[51]	男單Under-13[52]	男單Under-13[53]	男單Under-13[54]	男單Under-13[55]	男單Under-13[56]	男單Under-13[57]	男單Under-13[58]
10:00	女雙Under-15[3]	男單Under-13[59]	男單Under-13[60]	男單Under-13[61]	男單Under-13[62]	男單Under-13[63]	男單Under-13[64]	男單Under-13[65]	男單Under-13[66]	男單Under-13[67]
10:15	男單Under-13[68]	男單Under-13[69]	男單Under-13[70]	男單Under-13[71]	男單Under-13[72]	男單Under-13[73]	男單Under-13[74]	男單Under-13[75]	男單Under-13[76]	男單Under-13[77]
10:30	男單Under-13[78]	男單Under-13[79]	男單Under-13[80]	男單Under-13[81]	男單Under-13[82]	男單Under-13[83]	男單Under-13[84]	男單Under-13[85]	男單Under-13[86]	男單Under-13[87]
10:45	男單Under-13[88]	男單Under-13[89]	男單Under-13[90]	男單Under-11[1]	男單Under-11[2]	男單Under-11[3]	男單Under-11[4]	男單Under-11[5]	男單Under-11[6]	男單Under-11[7]
11:00	男單Under-11[8]	男單Under-11[9]	男單Under-11[10]	男單Under-11[11]	男單Under-11[12]	男單Under-11[13]	男單Under-11[14]	男單Under-11[15]	男單Under-11[16]	男單Under-11[17]
11:15	男單Under-11[18]	男單Under-11[19]	男單Under-11[20]	男單Under-11[21]	男單Under-11[22]	男單Under-11[23]	男單Under-11[24]	男單Under-11[25]	男單Under-15[1]	男單Under-15[2]
11:30	男單Under-15[3]	男單Under-15[4]	男單Under-15[5]	男單Under-15[6]	男單Under-15[7]	男單Under-15[8]	男單Under-15[9]	男單Under-15[10]	男單Under-15[11]	男單Under-15[12]
11:45	男單Under-15[13]	男單Under-15[14]	男單Under-15[15]	男單Under-15[16]	男單Under-15[17]	男單Under-15[18]	男單Under-15[19]	男單Under-15[20]	男單Under-15[21]	男單Under-11[26]
12:00	男單Under-11[27]	男單Under-11[28]	男單Under-11[29]	男單Under-11[30]	男單Under-11[31]	男單Under-11[32]	男單Under-11[33]	男單Under-11[34]	男單Under-11[35]	男單Under-11[36]
12:15	男單Under-11[37]	男單Under-11[38]	男單Under-11[39]	男單Under-11[40]	男單Under-11[41]	男單Under-11[42]	男單Under-11[43]	男單Under-11[44]	男單Under-11[45]	男單Under-11[46]
12:30	男單Under-11[47]	男單Under-11[48]	男單Under-11[49]	男單Under-11[50]	男單Under-15[22]	男單Under-15[23]	男單Under-15[24]	男單Under-15[25]	男單Under-15[26]	男單Under-15[27]
12:45	男單Under-15[28]	男單Under-15[29]	男單Under-15[30]	男單Under-15[31]	男單Under-15[32]	男單Under-15[33]	男單Under-15[34]	男單Under-15[35]	男單Under-15[36]	男單Under-15[37]
13:00	男單Under-15[38]	男單Under-15[39]	男單Under-15[40]	男單Under-15[41]	男單Under-15[42]	男單Under-11[51]	男單Under-11[52]	男單Under-11[53]	男單Under-11[54]	男單Under-11[55]
13:15	男單Under-11[56]	男單Under-11[57]	男單Under-11[58]	男單Under-11[59]	男單Under-11[60]	男單Under-11[61]	男單Under-11[62]	男單Under-11[63]	男單Under-11[64]	男單Under-11[65]
13:30	男單Under-11[66]	男單Under-11[67]	男單Under-11[68]	男單Under-11[69]	男單Under-11[70]	男單Under-11[71]	男單Under-11[72]	男單Under-11[73]	男單Under-11[74]	男單Under-11[75]
13:45	男單Under-15[43]	男單Under-15[44]	男單Under-15[45]	男單Under-15[46]	男單Under-15[47]	男單Under-15[48]	男單Under-15[49]	男單Under-15[50]	男單Under-15[51]	男單Under-15[52]
14:00	男單Under-15[53]	男單Under-15[54]	男單Under-15[55]	男單Under-15[56]	男單Under-15[57]	男單Under-15[58]	男單Under-15[59]	男單Under-15[60]	男單Under-15[61]	男單Under-15[62]
14:15	男單Under-15[63]	男單Under-17[1]	男單Under-17[2]	男單Under-17[3]	男單Under-17[4]	男單Under-17[5]	男單Under-17[6]	男單Under-17[7]	男單Under-13[91]	男單Under-13[92]
14:30	男單Under-13[93]	男單Under-13[94]	男單Under-13[95]	男單Under-13[96]	男單Under-13[97]	男單Under-13[98]	男單Under-13[99]	男單Under-13[100]	男單Under-13[101]	男單Under-13[102]
14:45	男單Under-13[103]	男單Under-13[104]	男單Under-19[1]	男單Under-19[2]	男單Under-19[3]	男單Under-19[4]	男單Under-19[5]	男單Under-19[6]	女單Under-15[1]	女單Under-15[2]
15:00	女單Under-15[3]	女單Under-15[4]	女單Under-15[5]	男單Under-11[76]	男單Under-11[77]	男單Under-11[78]	男單Under-11[79]	男單Under-11[80]	男單Under-11[81]	男單Under-11[82]
15:15	男單Under-11[83]	男單Under-15[64]	男單Under-15[65]	男單Under-15[66]	男單Under-15[67]	男單Under-17[8]	男單Under-17[9]	男單Under-17[10]	男單Under-17[11]	男單Under-17[12]
15:30	男單Under-17[13]	男單Under-17[14]	男單Under-13[105]	男單Under-13[106]	男單Under-13[107]	男單Under-13[108]	男單Under-13[109]	男單Under-13[110]	男單Under-13[111]	男單Under-13[112]
15:45	男單Under-19[7]	男單Under-19[8]	男單Under-19[9]	男單Under-19[10]	男單Under-19[11]	男單Under-19[12]	女單Under-15[6]	女單Under-15[7]	女單Under-15[8]	女單Under-15[9]
16:00	女單Under-15[10]	男單Under-11[84]	男單Under-11[85]	男單Under-11[86]	男單Under-11[87]	男單Under-11[88]	男單Under-11[89]	男單Under-11[90]	男單Under-11[91]	男單Under-15[68]
16:15	男單Under-15[69]	男單Under-15[70]	男單Under-15[71]	男單Under-15[72]	男單Under-15[73]	男單Under-15[74]	男單Under-15[75]	男單Under-17[15]	男單Under-17[16]	男單Under-17[17]
16:30	男單Under-17[18]	男單Under-17[19]	男單Under-17[20]	男單Under-17[21]	男單Under-13[113]	男單Under-13[114]	男單Under-13[115]	男單Under-13[116]	男單Under-19[13]	男單Under-19[14]
16:45	男單Under-19[15]	男單Under-19[16]	男單Under-19[17]	男單Under-19[18]	女單Under-15[11]	女單Under-15[12]	女單Under-15[13]	女單Under-15[14]	女單Under-15[15]	男單Under-11[92]
17:00	男單Under-11[93]	男單Under-11[94]	男單Under-11[95]	男單Under-15[76]	男單Under-15[77]	男單Under-15[78]	男單Under-15[79]	男單Under-17[22]	男單Under-17[23]	男單Under-17[24]
17:15	男單Under-13[117]	男單Under-13[118]	男單Under-19[19]	男單Under-19[20]	女單Under-15[16]	女單Under-15[17]				
17:30	男單Under-11[96]	男單Under-11[97]	男單Under-15[80]	男單Under-15[81]	男單Under-17[25]	男單Under-17[26]				
17:45	男單Under-13[119]	男單Under-13[120]	男單Under-19[21]	男單Under-19[22]	女單Under-15[18]	女單Under-15[19]				
18:00	男單Under-11[98]	男單Under-11[99]	男單Under-15[82]	男單Under-15[83]	男單Under-17[27]	男單Under-17[28]				

2019年滾水聯盟盃全國羽球公開賽

場次時間對照表

108年3月2日(六)

地點：滾水羽球燕巢館

Court 1 ~ Court 10										
08:30									男雙Under-13[1]	男雙Under-13[2]
08:45	滾水接力賽[1]	滾水接力賽[2]	滾水接力賽[3]	滾水接力賽[4]	滾水接力賽[5]	滾水接力賽[6]	滾水接力賽[7]	滾水接力賽[8]	男雙Under-13[3]	男雙Under-13[4]
09:00									男雙Under-13[5]	男雙Under-13[6]
09:15			男子 國小聯盟組 [1]	男子 國小聯盟組 [2]	男子 國小聯盟組 [3]	男子 國小聯盟組 [4]	男雙Under-13[7]	男雙Under-13[8]	男雙Under-13[9]	男雙Under-13[10]
09:30	輪椅聯盟組[1]	輪椅聯盟組[2]					男雙Under-13[11]	女單Under-13[1]	女單Under-13[2]	女單Under-13[3]
09:45							女單Under-13[4]	女單Under-13[5]	女單Under-13[6]	女單Under-13[7]
10:00	開 幕 典 禮									
10:30									女單Under-13[8]	女單Under-13[9]
10:45	滾水接力賽[9]	滾水接力賽[10]	滾水接力賽[11]	滾水接力賽[12]	滾水接力賽[13]	滾水接力賽[14]	滾水接力賽[15]	滾水接力賽[16]	女單Under-13[10]	男雙Under-13[12]
11:00									男雙Under-13[13]	男雙Under-13[14]
11:15			男子 國小聯盟組 [5]	男子 國小聯盟組 [6]	男子 國小聯盟組 [7]	男子 國小聯盟組 [8]	男雙Under-13[15]	男雙Under-13[16]	男雙Under-13[17]	男雙Under-13[18]
11:30	輪椅聯盟組[3]	輪椅聯盟組[4]					男雙Under-13[19]	男雙Under-13[20]	男雙Under-13[21]	男雙Under-13[22]
11:45							女單Under-13[11]	女單Under-13[12]	女單Under-13[13]	女單Under-13[14]
12:00									女單Under-13[15]	女單Under-13[16]
12:15	滾水接力賽[17]	滾水接力賽[18]	滾水接力賽[19]	滾水接力賽[20]	滾水接力賽[21]	滾水接力賽[22]	滾水接力賽[23]	滾水接力賽[24]	女單Under-13[17]	女單Under-13[18]
12:30									女單Under-13[19]	女單Under-13[20]
12:45			男子 國小聯盟組 [9]	男子 國小聯盟組 [10]	男子 國小聯盟組 [11]	男子 國小聯盟組 [12]	男雙Under-13[23]	男雙Under-13[24]	男雙Under-13[25]	男雙Under-13[26]
13:00	輪椅聯盟組[5]	輪椅聯盟組[6]					男雙Under-13[27]	男雙Under-13[28]	男雙Under-13[29]	男雙Under-13[30]
13:15							男雙Under-13[31]	男雙Under-13[32]	男雙Under-13[33]	女單Under-13[21]
13:30			女單Under-13[22]	女單Under-13[23]	女單Under-13[24]	女單Under-13[25]	女單Under-13[26]	女單Under-13[27]	女單Under-13[28]	女單Under-13[29]
13:45	滾水接力賽[25]	滾水接力賽[26]	女單Under-13[30]	男雙Under-15[1]	男雙Under-15[2]	男雙Under-15[3]	男雙Under-15[4]	男雙Under-15[5]	男雙Under-15[6]	男雙Under-15[7]
14:00			男雙Under-11[1]	男雙Under-11[2]	男雙Under-11[3]	男雙Under-11[4]	男雙Under-11[5]	男單Under-09[1]	男單Under-09[2]	男單Under-09[3]
14:15	男子 國小聯盟組 [13]	男單Under-09[4]	男單Under-09[5]	男單Under-09[6]	男單Under-09[7]	男單Under-09[8]	女雙Under-11[1]	女雙Under-11[2]	女單Under-09[1]	女單Under-09[2]
14:30		女單Under-09[3]	女單Under-09[4]	女單Under-09[5]	男雙Under-15[8]	男雙Under-15[9]	男雙Under-15[10]	男雙Under-15[11]	男雙Under-15[12]	男雙Under-15[13]
14:45		男雙Under-15[14]	男雙Under-11[6]	男雙Under-11[7]	男雙Under-11[8]	男雙Under-11[9]	男雙Under-11[10]	男雙Under-17[1]	男雙Under-17[2]	男雙Under-17[3]
15:00			男雙Under-17[4]	男單Under-09[9]	男單Under-09[10]	男單Under-09[11]	男單Under-09[12]	男單Under-09[13]	男單Under-09[14]	男單Under-09[15]
15:15	滾水接力賽[27]	滾水接力賽[28]	男單Under-09[16]	男雙Under-13[34]	女單Under-13[31]	女雙Under-11[3]	女雙Under-11[4]	女單Under-09[6]	女單Under-09[7]	女單Under-09[8]
15:30			女單Under-09[9]	女單Under-09[10]	男雙Under-15[15]	男雙Under-15[16]	男雙Under-15[17]	男雙Under-15[18]	男雙Under-15[19]	男雙Under-15[20]
15:45	男雙Under-15[21]	男雙Under-11[11]	男雙Under-11[12]	男雙Under-11[13]	男雙Under-11[14]	男雙Under-11[15]	男雙Under-17[5]	男雙Under-17[6]	男雙Under-17[7]	男雙Under-17[8]
16:00	男單Under-09[17]	男單Under-09[18]	男單Under-09[19]	男單Under-09[20]	男單Under-09[21]	男單Under-09[22]	男單Under-09[23]	男單Under-09[24]	女雙Under-13[1]	女雙Under-13[2]
16:15	女雙Under-13[3]	男雙Under-19[1]	男雙Under-19[2]	男雙Under-13[35]	男雙Under-13[36]	男雙Under-13[37]	男雙Under-13[38]	女單Under-13[32]	女單Under-13[33]	女單Under-13[34]
16:30		女單Under-13[35]	女雙Under-11[5]	女雙Under-11[6]	女單Under-09[11]	女單Under-09[12]	女單Under-09[13]	女單Under-09[14]	女單Under-09[15]	男雙Under-15[22]
16:45	滾水接力賽[29]	男雙Under-15[23]	男雙Under-15[24]	男雙Under-11[16]	男雙Under-17[9]	男雙Under-17[10]	男雙Under-17[11]	男雙Under-17[12]	男單Under-09[25]	男單Under-09[26]
17:00		男單Under-09[27]	女雙Under-13[4]	女雙Under-13[5]	女雙Under-13[6]	男雙Under-19[3]	男雙Under-19[4]	男雙Under-13[39]	男雙Under-13[40]	女單Under-13[36]
17:15	女單Under-13[37]	女雙Under-11[7]	女雙Under-11[8]	女單Under-09[16]	女單Under-09[17]	男雙Under-15[25]	男雙Under-15[26]	男雙Under-11[17]	男雙Under-11[18]	男雙Under-17[13]
17:30	男單Under-09[28]	男單Under-09[29]	女雙Under-13[7]	女雙Under-13[8]	女雙Under-13[9]	男雙Under-19[5]	男雙Under-19[6]	男雙Under-13[41]	男雙Under-13[42]	
17:45	女單Under-13[38]	女單Under-13[39]	女雙Under-11[9]	女雙Under-11[10]	女單Under-09[18]	女單Under-09[19]	男雙Under-15[27]	男雙Under-15[28]		
18:00	男雙Under-11[19]	男雙Under-11[20]	男雙Under-17[14]	男單Under-09[30]	男單Under-09[31]	女雙Under-13[10]	男雙Under-19[7]			

2019年滾水聯盟盃全國羽球公開賽

場次時間對照表

108年3月3日(日)

地點：滾水羽球燕巢館

Court 1 ~ Court 10										
08:30					男雙公開組[1]	男雙公開組[2]	男雙公開組[3]	男雙公開組[4]	男雙公開組[5]	混雙青年組[1]
08:45	大專聯盟組[1]	大專聯盟組[2]	大專聯盟組[3]	大專聯盟組[4]	混雙青年組[2]	混雙青年組[3]	混雙青年組[4]	混雙青年組[5]	混雙青年組[6]	混雙青年組[7]
09:00					混雙壯年組[1]	混雙壯年組[2]	女雙Under-17[1]	女雙Under-17[2]	混雙勇健組[1]	混雙勇健組[2]
09:15				混雙勇健組[3]	混雙公開組[1]	混雙公開組[2]	混雙公開組[3]	男雙大專組[1]	男雙大專組[2]	男雙大專組[3]
09:30	女子聯盟組[1]	女子聯盟組[2]	滾水聯盟組[1]	男雙公開組[6]	男雙公開組[7]	男雙公開組[8]	男雙公開組[9]	男雙公開組[10]	混雙青年組[8]	混雙青年組[9]
09:45				混雙青年組[10]	混雙青年組[11]	混雙青年組[12]	混雙青年組[13]	混雙青年組[14]	混雙壯年組[3]	混雙壯年組[4]
10:00					女雙Under-17[3]	女雙Under-17[4]	混雙勇健組[4]	混雙勇健組[5]	混雙勇健組[6]	混雙公開組[4]
10:15	大專聯盟組[5]	大專聯盟組[6]	大專聯盟組[7]	大專聯盟組[8]	混雙公開組[5]	混雙公開組[6]	男雙大專組[4]	男雙大專組[5]	男雙大專組[6]	男雙公開組[11]
10:30					男雙公開組[12]	男雙公開組[13]	男雙公開組[14]	男雙公開組[15]	混雙青年組[15]	混雙青年組[16]
10:45				混雙青年組[17]	混雙青年組[18]	混雙青年組[19]	混雙青年組[20]	混雙青年組[21]	混雙壯年組[5]	混雙壯年組[6]
11:00	女子聯盟組[3]	女子聯盟組[4]	滾水聯盟組[2]	女雙Under-17[5]	女雙Under-17[6]	混雙勇健組[7]	混雙勇健組[8]	混雙勇健組[9]	混雙公開組[7]	混雙公開組[8]
11:15				混雙公開組[9]	男雙大專組[7]	男雙大專組[8]	男雙大專組[9]	男雙公開組[16]	混雙青年組[22]	混雙青年組[23]
11:30					混雙青年組[24]	混雙壯年組[7]	混雙勇健組[10]	女單Under-11[1]	女單Under-11[2]	女單Under-11[3]
11:45	大專聯盟組[9]	大專聯盟組[10]	大專聯盟組[11]	大專聯盟組[12]	女單Under-11[4]	女單Under-11[5]	女單Under-11[6]	女單Under-11[7]	女單Under-11[8]	女單Under-11[9]
12:00					女單Under-11[10]	混雙公開組[10]	男雙大專組[10]	混雙青年組[25]	混雙青年組[26]	男雙青年組[1]
12:15				男雙青年組[2]	男雙青年組[3]	男雙青年組[4]	男雙青年組[5]	男雙青年組[6]	男雙青年組[7]	男雙青年組[8]
12:30	女子聯盟組[5]	女子聯盟組[6]	滾水聯盟組[3]	男雙公開組[17]	女單Under-11[11]	女單Under-11[12]	女單Under-11[13]	女單Under-11[14]	女單Under-11[15]	女單Under-11[16]
12:45				女單Under-11[17]	女單Under-11[18]	女單Under-11[19]	女單Under-11[20]	混雙青年組[27]	混雙青年組[28]	男單大專組[1]
13:00		男單大專組[2]	男單大專組[3]	男單大專組[4]	男單大專組[5]	男單大專組[6]	男單大專組[7]	男雙青年組[9]	男雙青年組[10]	男雙青年組[11]
13:15	大專聯盟組[13]	男雙青年組[12]	男雙青年組[13]	男雙青年組[14]	男雙青年組[15]	男雙青年組[16]	女雙青年組[1]	女雙青年組[2]	女雙青年組[3]	女雙青年組[4]
13:30		男單大專組[8]	男單大專組[9]	男單大專組[10]	男單大專組[11]	男單大專組[12]	男單大專組[13]	男單大專組[14]	女單大專組[1]	女單大專組[2]
13:45		男雙壯年組[1]	男雙壯年組[2]	男雙壯年組[3]	男雙壯年組[4]	男雙壯年組[5]	男單公開組[1]	男單公開組[2]	男單公開組[3]	男單公開組[4]
14:00	女子聯盟組[7]	男單公開組[5]	男單公開組[6]	女雙壯年組[1]	女雙壯年組[2]	女單Under-11[21]	女單Under-11[22]	女單Under-11[23]	女單Under-11[24]	女單Under-11[25]
14:15		女單Under-11[26]	女單Under-11[27]	女單Under-11[28]	女單Under-11[29]	女單Under-11[30]	男雙青年組[17]	男雙青年組[18]	男雙青年組[19]	男雙青年組[20]
14:30	男雙青年組[21]	男雙青年組[22]	男雙青年組[23]	男雙青年組[24]	女雙青年組[5]	女雙青年組[6]	女雙青年組[7]	女雙青年組[8]	男單大專組[15]	男單大專組[16]
14:45	男單大專組[17]	男單大專組[18]	男單大專組[19]	男單大專組[20]	男單大專組[21]	女單大專組[3]	女單大專組[4]	男雙壯年組[6]	男雙壯年組[7]	男雙壯年組[8]
15:00	男雙壯年組[9]	男雙壯年組[10]	男單公開組[7]	男單公開組[8]	男單公開組[9]	男單公開組[10]	男單公開組[11]	男單公開組[12]	男雙勇健組[1]	男雙勇健組[2]
15:15	男雙勇健組[3]	男雙勇健組[4]	女雙壯年組[3]	女雙壯年組[4]	女單Under-11[31]	女單Under-17[1]	女單Under-17[2]	女單Under-17[3]	男雙青年組[25]	男雙青年組[26]
15:30	女雙青年組[9]	女雙青年組[10]	女雙青年組[11]	女雙青年組[12]	男單大專組[22]	女單大專組[5]	女單大專組[6]	男雙壯年組[11]	男雙壯年組[12]	男雙壯年組[13]
15:45	男雙壯年組[14]	男雙壯年組[15]	男單公開組[13]	男單公開組[14]	男單公開組[15]	男單公開組[16]	男單公開組[17]	男單公開組[18]	男雙勇健組[5]	男雙勇健組[6]
16:00	男雙勇健組[7]	男雙勇健組[8]	女雙壯年組[5]	女雙壯年組[6]	女單Under-11[32]	女單Under-11[33]	女單Under-11[34]	女單Under-11[35]	女單Under-17[4]	女單Under-17[5]
16:15	女單Under-17[6]	男雙青年組[27]	男雙青年組[28]	女雙青年組[13]	男單大專組[23]	男單大專組[24]	女單大專組[7]	女單大專組[8]	男雙壯年組[16]	
16:30	男單公開組[19]	男單公開組[20]	男雙勇健組[9]	男雙勇健組[10]	男雙勇健組[11]	男雙勇健組[12]	女雙壯年組[7]	女雙壯年組[8]		
16:45	女單Under-11[36]	女單Under-11[37]	女單Under-17[7]	女單Under-17[8]	女單Under-17[9]	男雙青年組[29]	男雙青年組[30]	女雙青年組[14]		
17:00	男單大專組[25]	男單大專組[26]	女單大專組[9]	女單大專組[10]	男雙壯年組[17]	男單公開組[21]	男單公開組[22]	男雙勇健組[13]		
17:15	女雙壯年組[9]	女雙壯年組[10]	女單Under-11[38]	女單Under-11[39]	女單Under-17[10]					

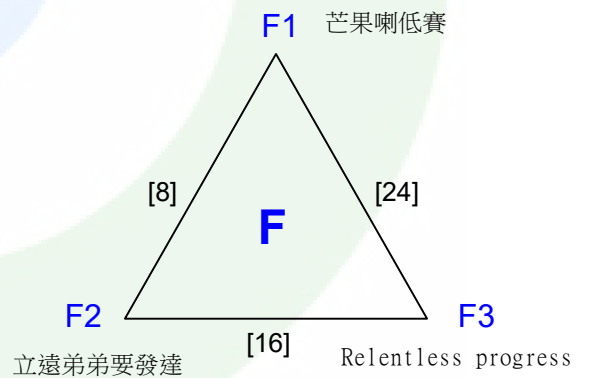
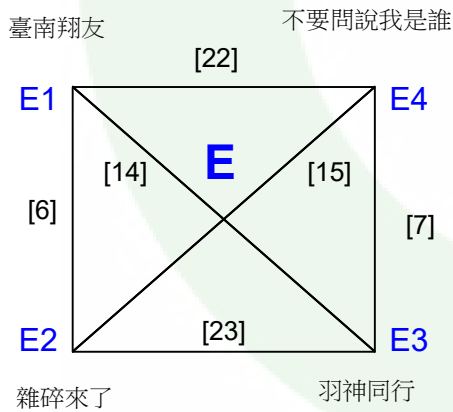
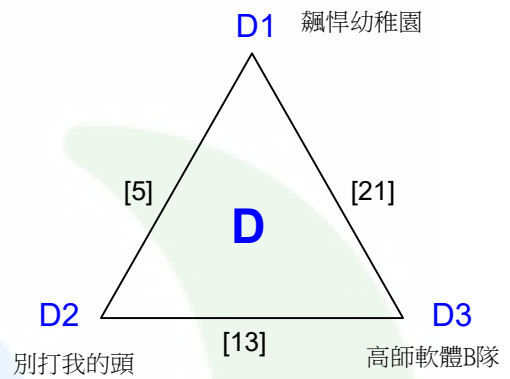
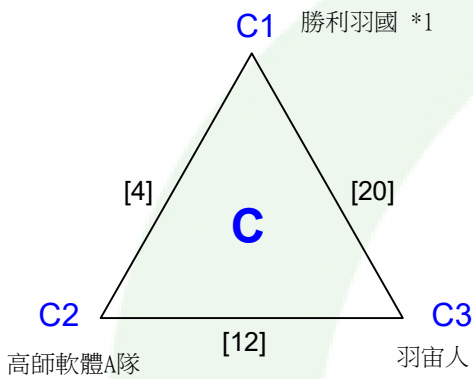
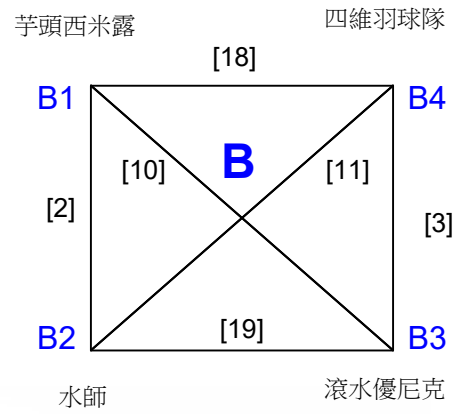
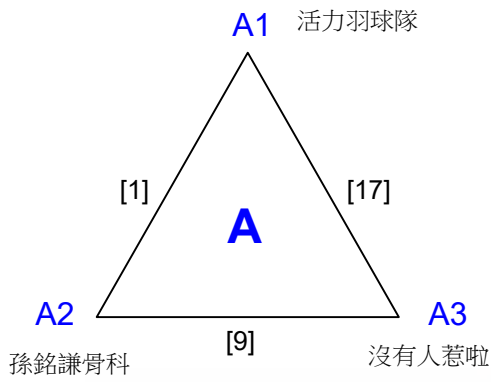

決賽:抽籤決定位置

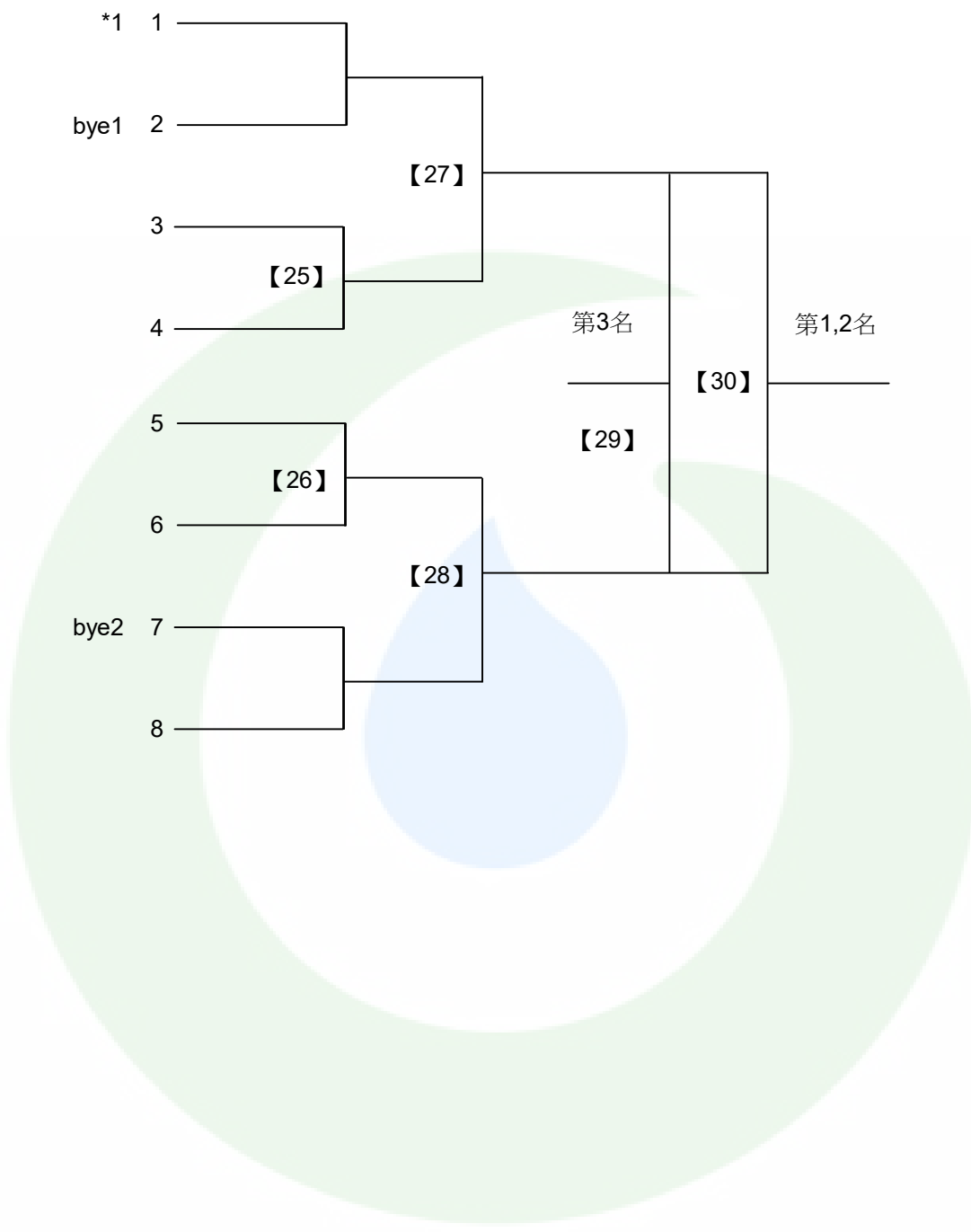

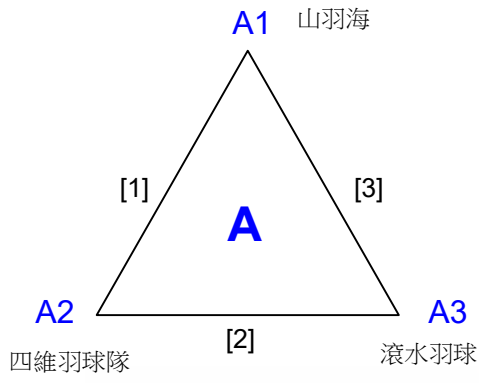

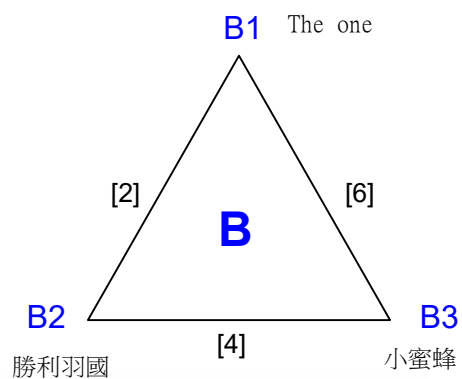
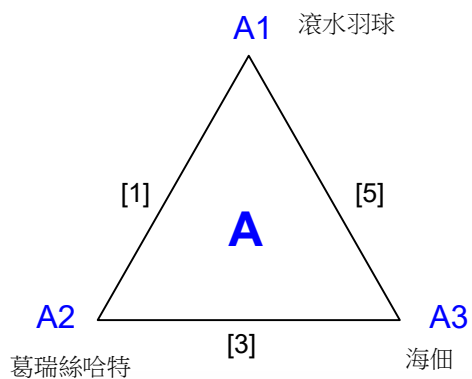

決賽:抽籤決定位置

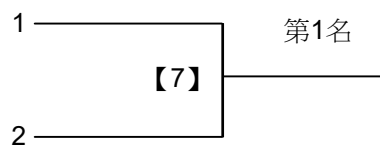

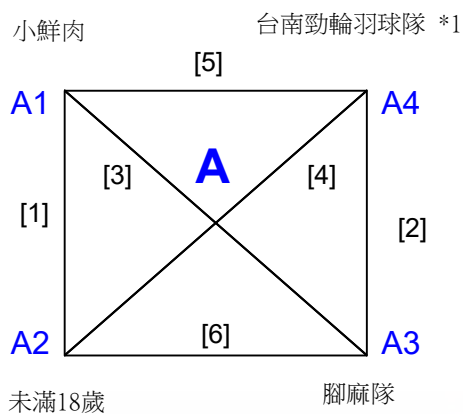

嘉南藥理大學 *1

屏東科大休運系

樹德科大室內設計

高師軟體

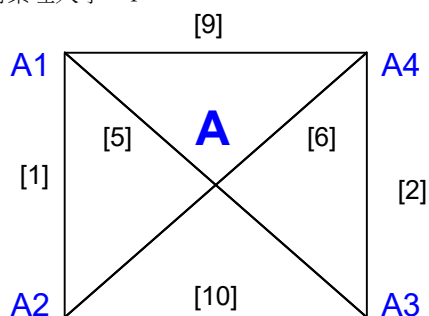

高大電機

慈惠醫專休管科

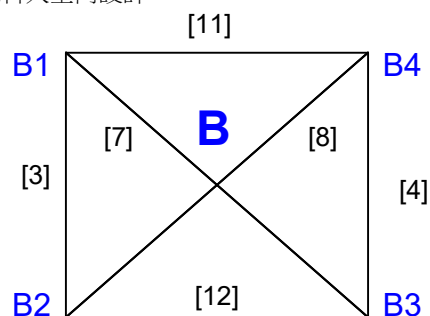

義守醫管

第一行銷，行銷第一



決賽:抽籤決定位置

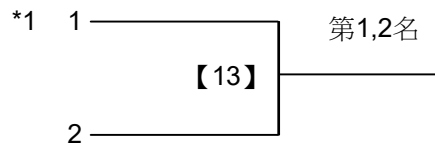

臺中市西區中正國小

崇學國小A

高雄市鼓山國小-藍

南市文化國小

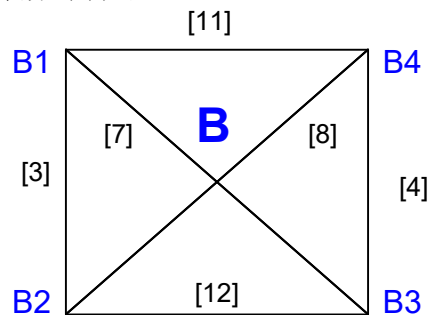
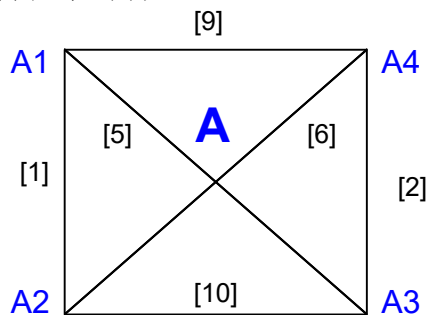

莊敬國小紅紅隊

高雄市鼓山國小-紅

崇學國小B

莊敬國小



決賽:抽籤決定位置

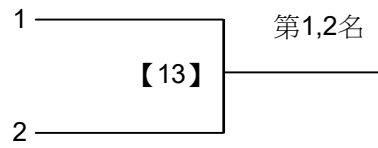

黃品皓 八年級 蕭寶翔
【13】

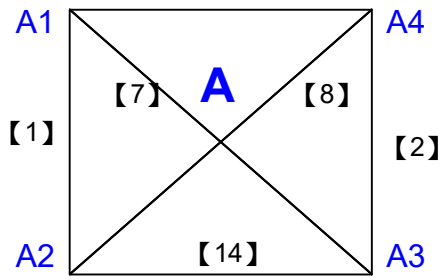

洪靖童 枋寮高中 侯展承

B1 林鴻仁 南區羽球 *1

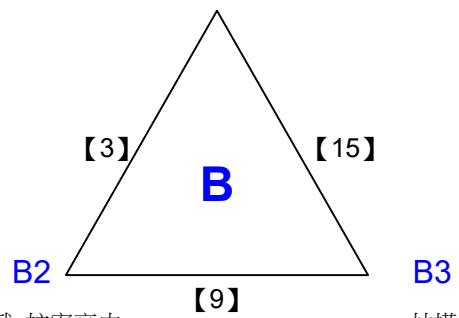

熊維斌 枋寮高中 林樺

C1 劉賢麒 滾水慈惠醫專 *2

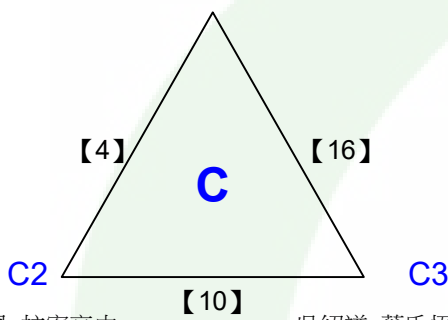

林于恩 枋寮高中 吳紹謙 葉氏悟羽臺南大學

郭佳哲 葉氏悟羽 崇學 高偉傑 鳳山商工
【17】

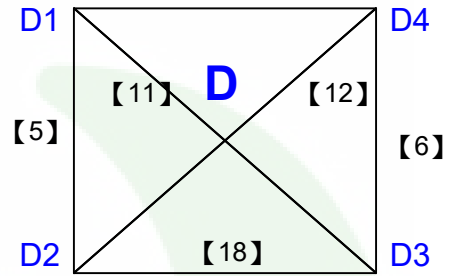

陳則儒 枋寮高中 黃冠銘 亞柏雄中

決賽:抽籤決定位置

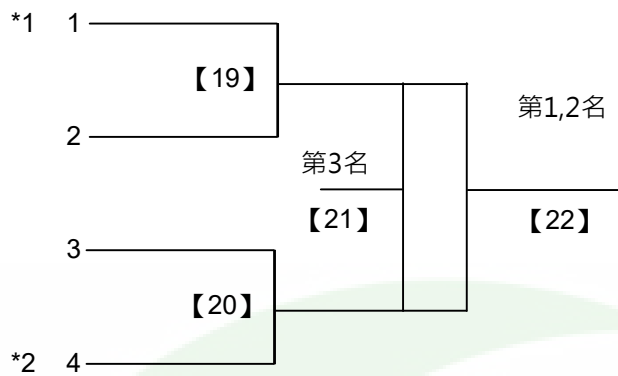

取2名

共11籤

吳存濬 瑞祥高中 莊閔傑 台南大學葉氏悟羽
 廖柏霖 仁武高中 【11】 洪英源 葉氏悟羽

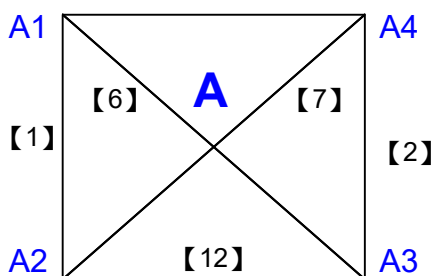

蕭攀休 海鴻高大 陳威辛
 蔡昀叡 高醫水行俠 蕭寶翔

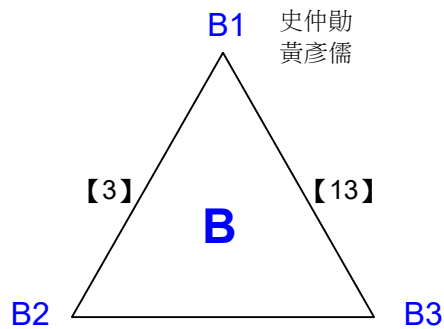

張俊裕 長榮大學 史仲勛
 林益安 長榮大學 黃彥儒
 胡皓翔
 陳柏宇

陳正益 騰耀羽球 王裕超
 邱郁文 騰耀羽球 【14】 薛清隆

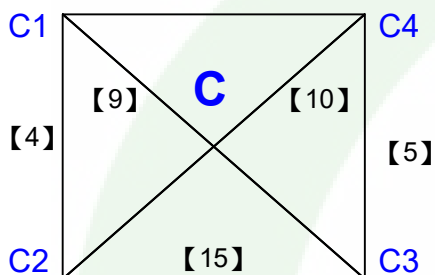

郭佳哲 葉氏悟羽崇學國小 廖建成 勢必得
 吳紹謙 葉氏悟羽臺南大學 張明傑 元三南區羽球

決賽:抽籤決定位置

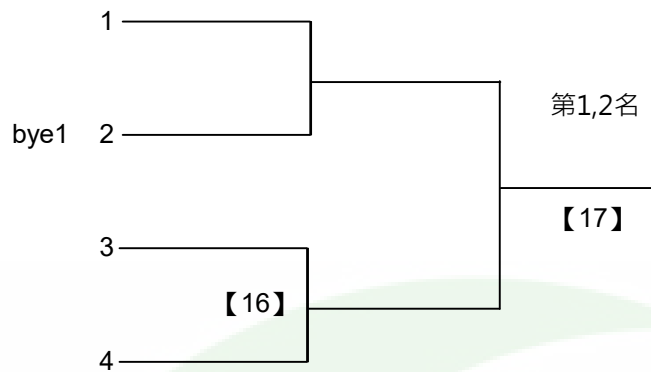

取2名

共7籤

陳思翰 女羽
鄭秀琴 女羽

MAN TZU YUAN Lee' s badminton 亞柏雄中
林思雲 亞柏雄中

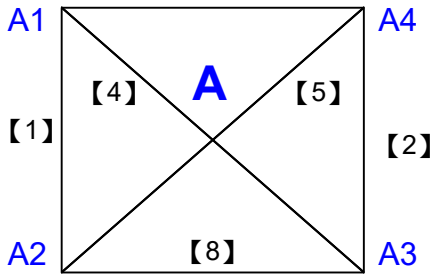

胡皓翔
莊紫紘

蕭攀休 海鴻高大
陳圓融 高雄大學

B1 史仲勛
王筠竺

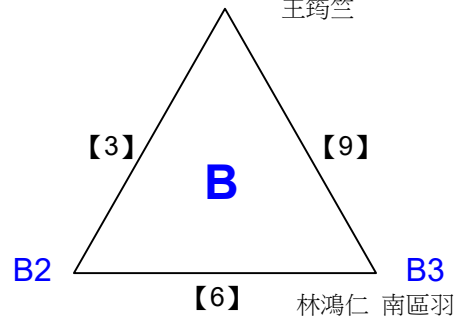

林樺
林曉清

林鴻仁 南區羽球
詹書茜 南區羽球



決賽:抽籤決定位置

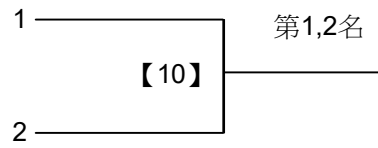

2019年滾水聯盟盃全國羽球公開賽

男雙壯年組

取2名

共11籤

許皓傑 姜軍
施凡勤 姜軍

邱俊傑
邱文信

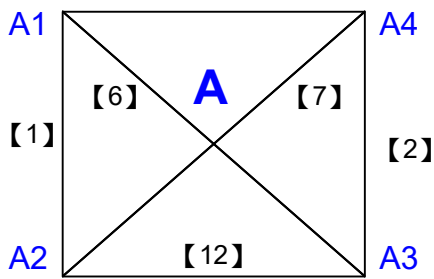

莊正文 山羽海
林正瑋 山羽海

蔡誌欣
李昭意

鄭國田 活力羽球隊
楊志偉 活力羽球隊

薛州男 佐佑
鄭勝錯 佐佑

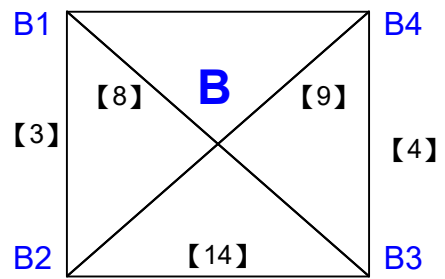

黃彥超 力羽美
蔡松育 力羽美

許耀中 加賀金促咪
陳柏榮 加賀金促咪

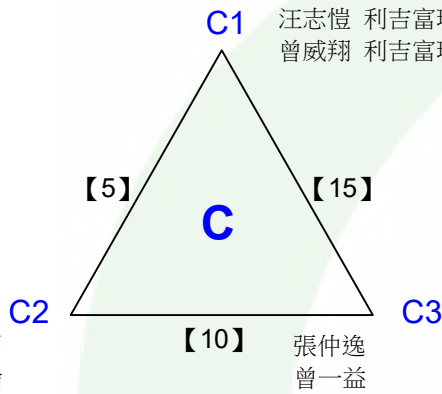

汪志愷 利吉富玻璃-羽過天晴 *1
曾威翔 利吉富玻璃-羽過天晴

鄭健川
許皓綸

張仲逸
曾一益

決賽:抽籤決定位置

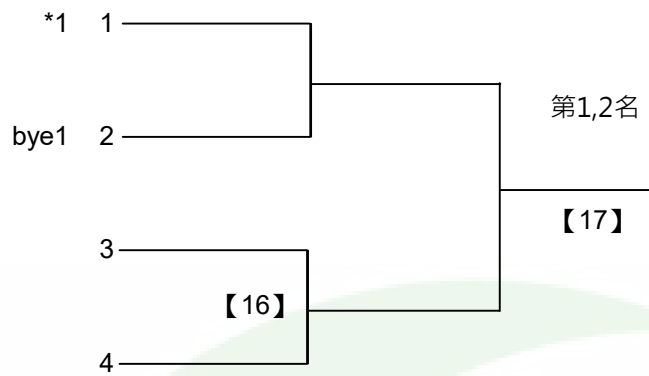

取2名

共8籤

何宗益 臺南翔友
施慶昇 臺南翔友

黃昱銓
王浩瓊

【9】

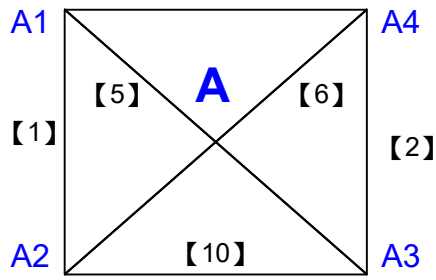

林義隆
楊政順

劉楨鎧 羽郎共舞
史博信 羽郎共舞

錢孔榮 海量
陳瑞林 海量

林柏宏 山羽海
陳文昌 山羽海

【11】

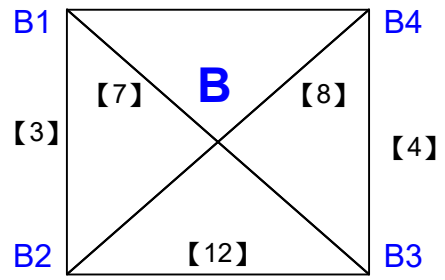

張經坤 羽勢無爭
王瑞賓 羽勢無爭

洪國章
蔡坤典

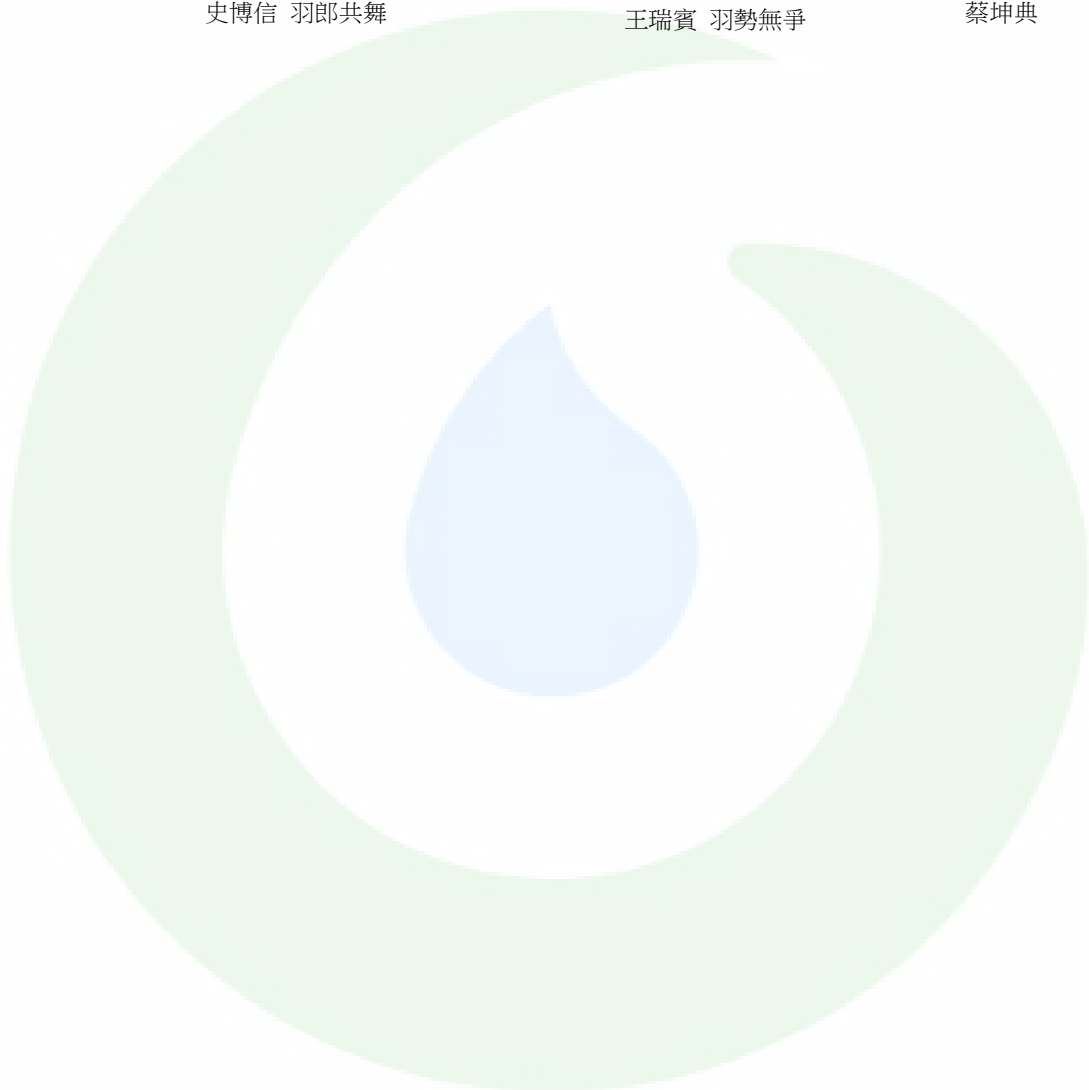

決賽:抽籤決定位置

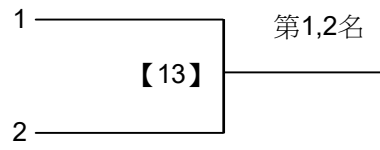

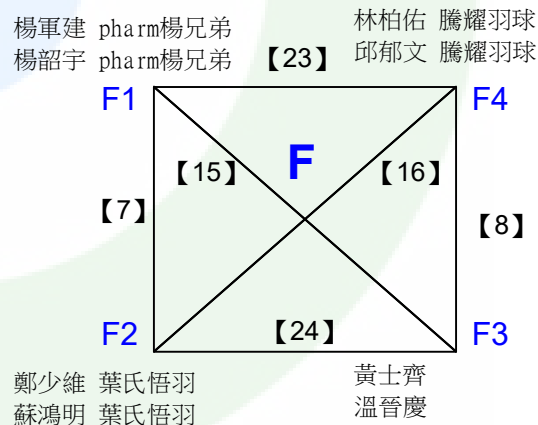
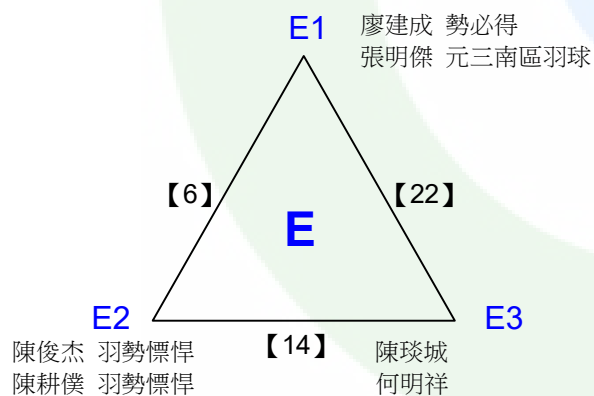
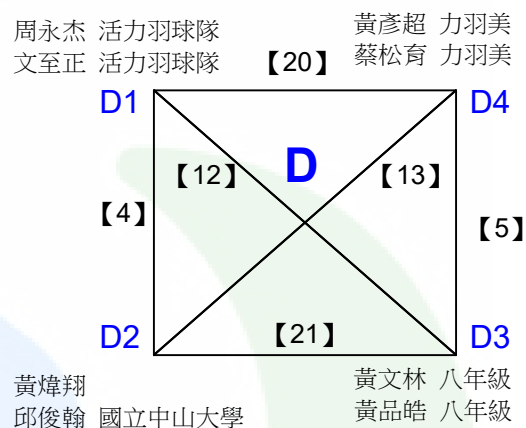
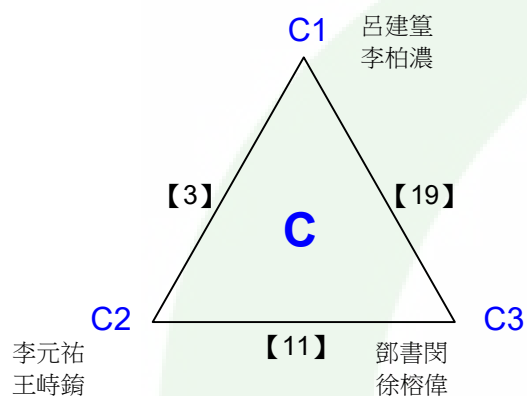
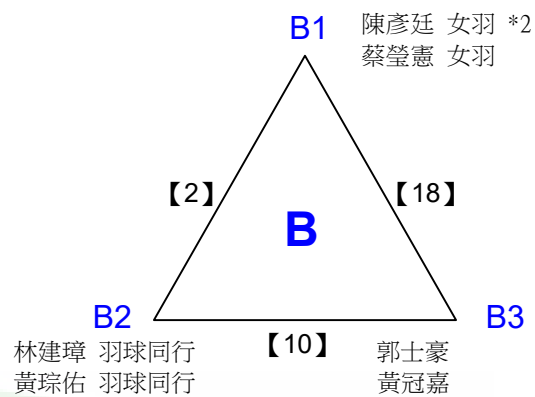
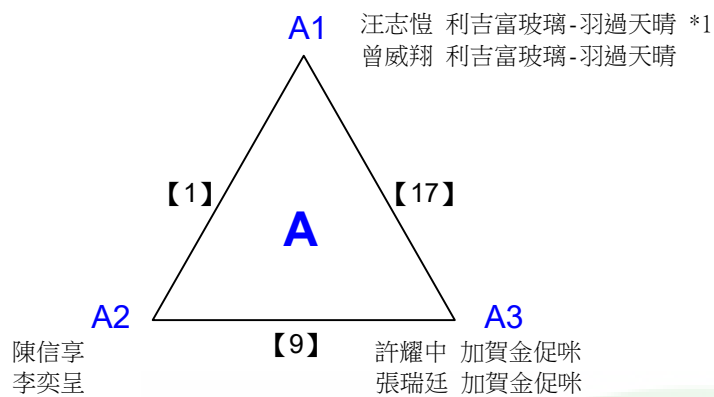

決賽:抽籤決定位置

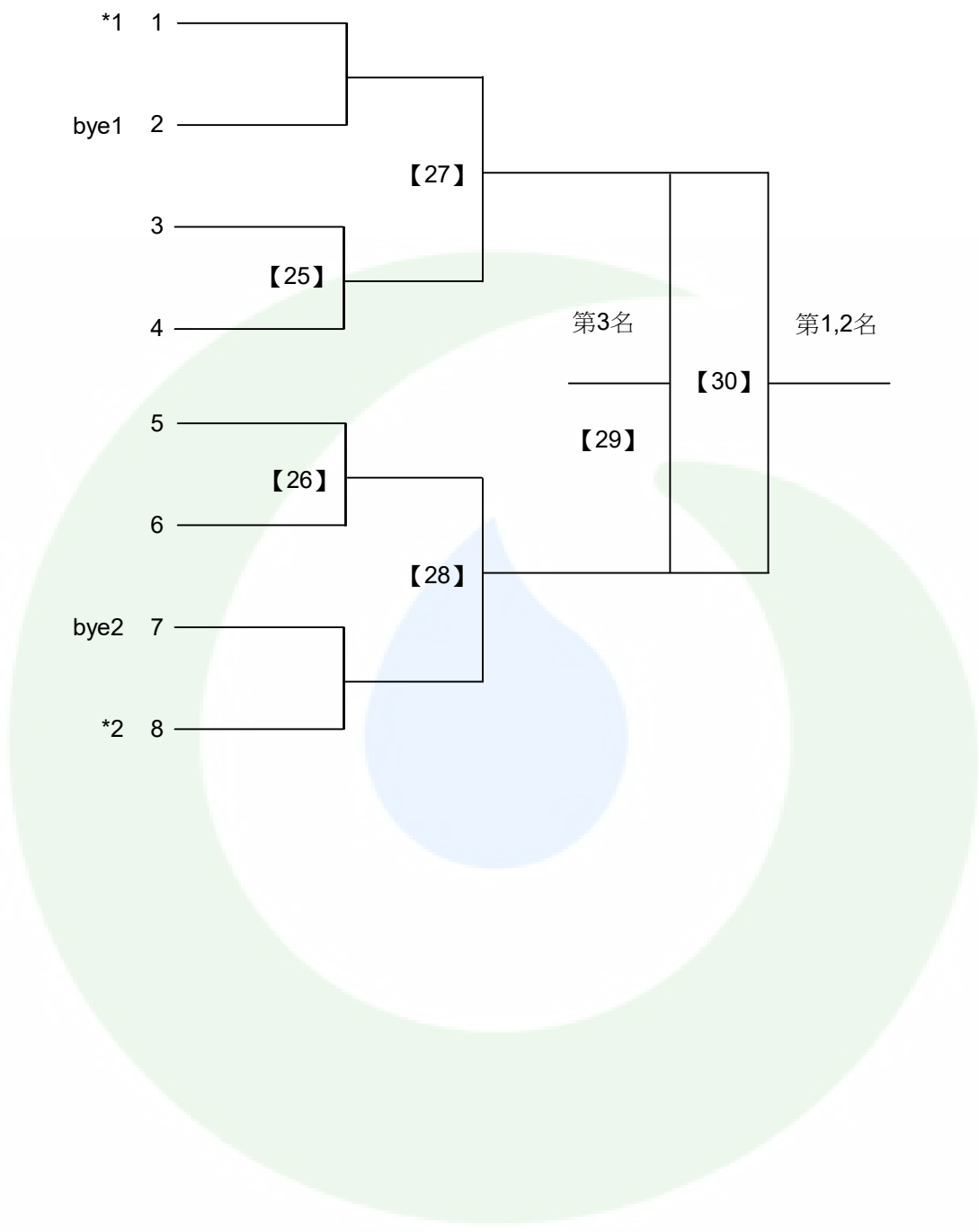

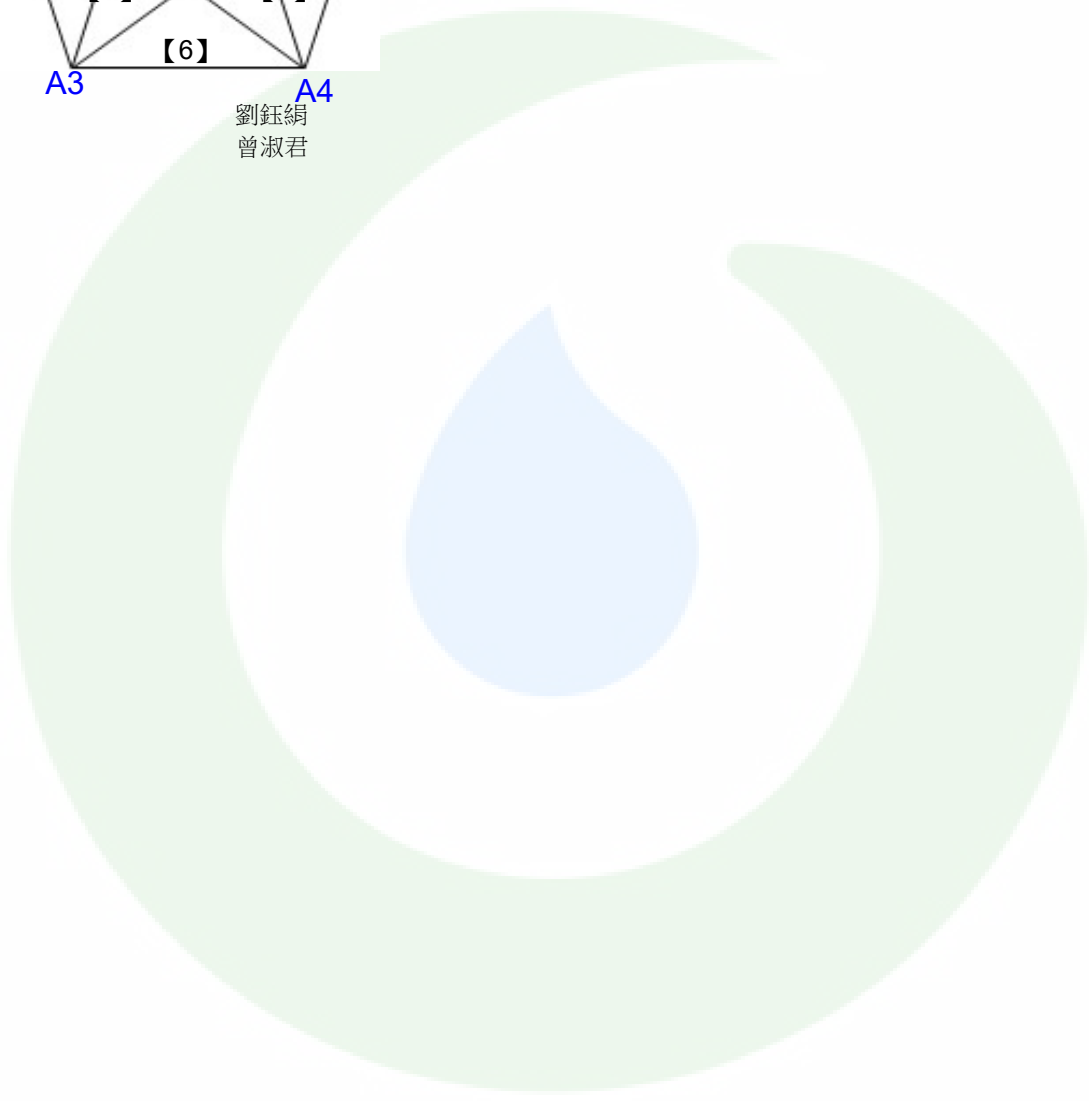
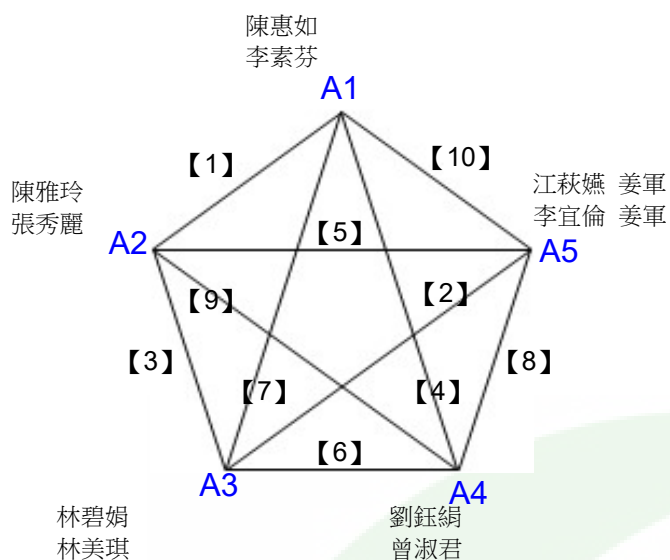

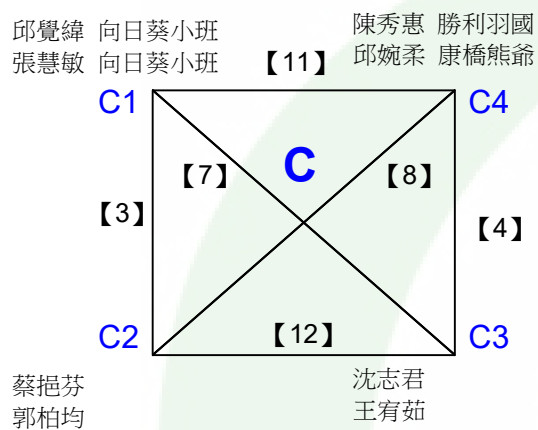
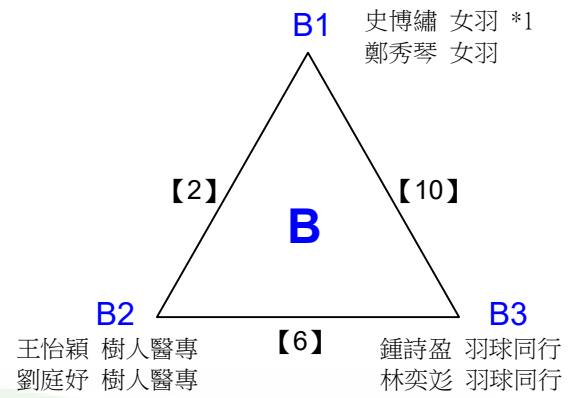
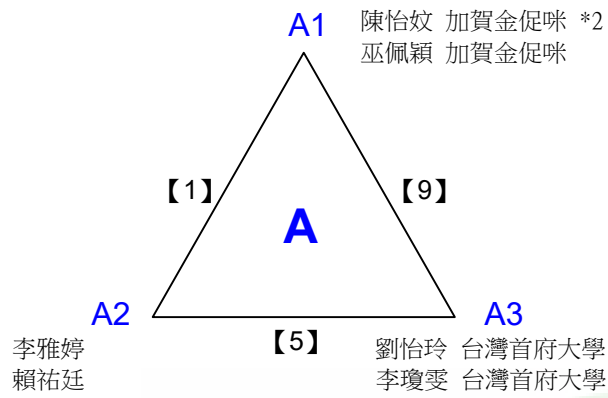

決賽:抽籤決定位置

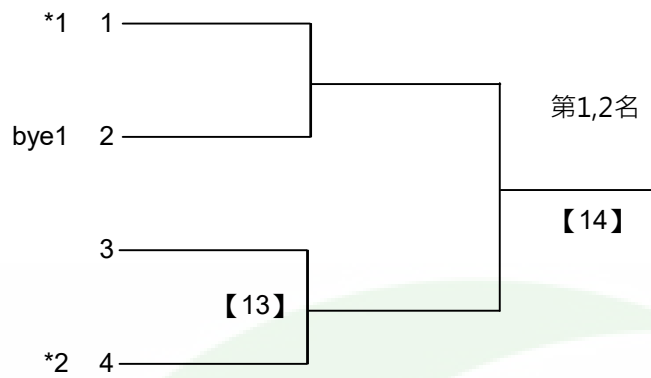

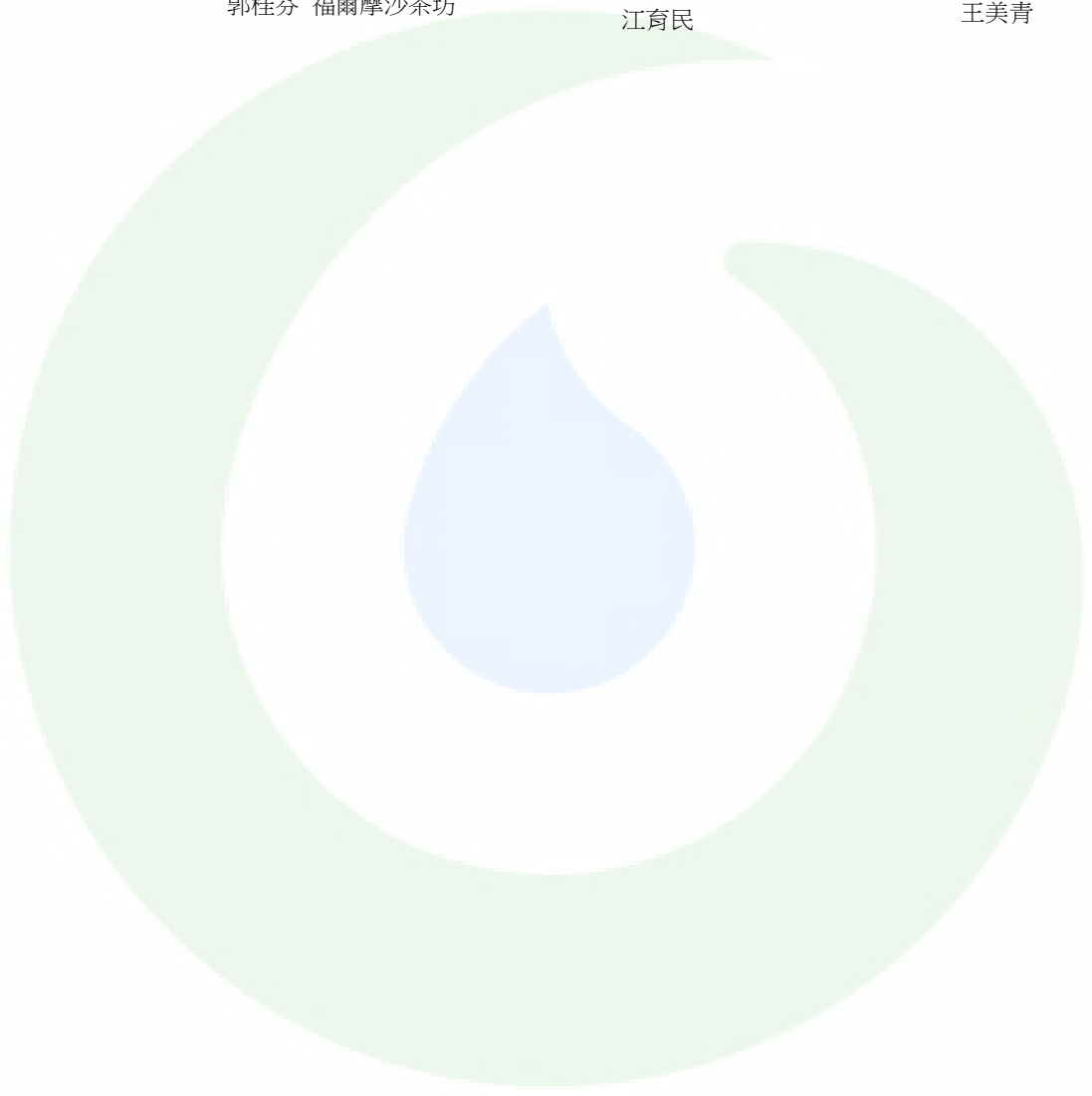
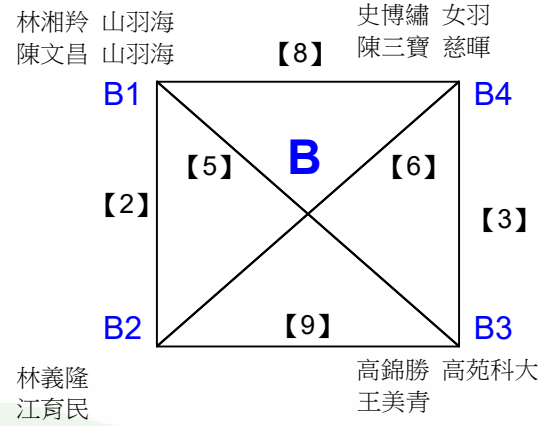
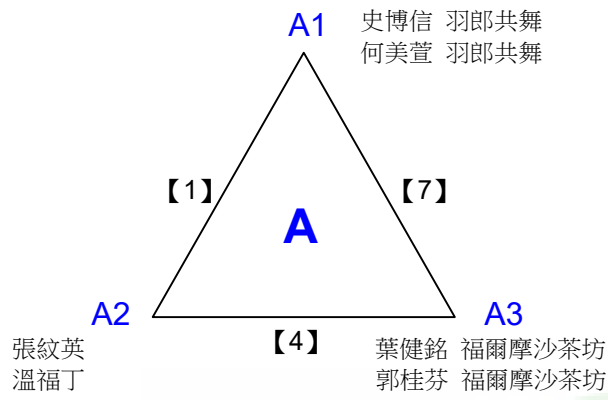

決賽:抽籤決定位置

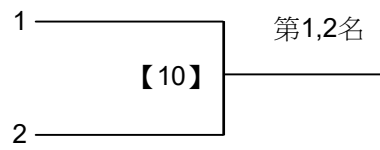

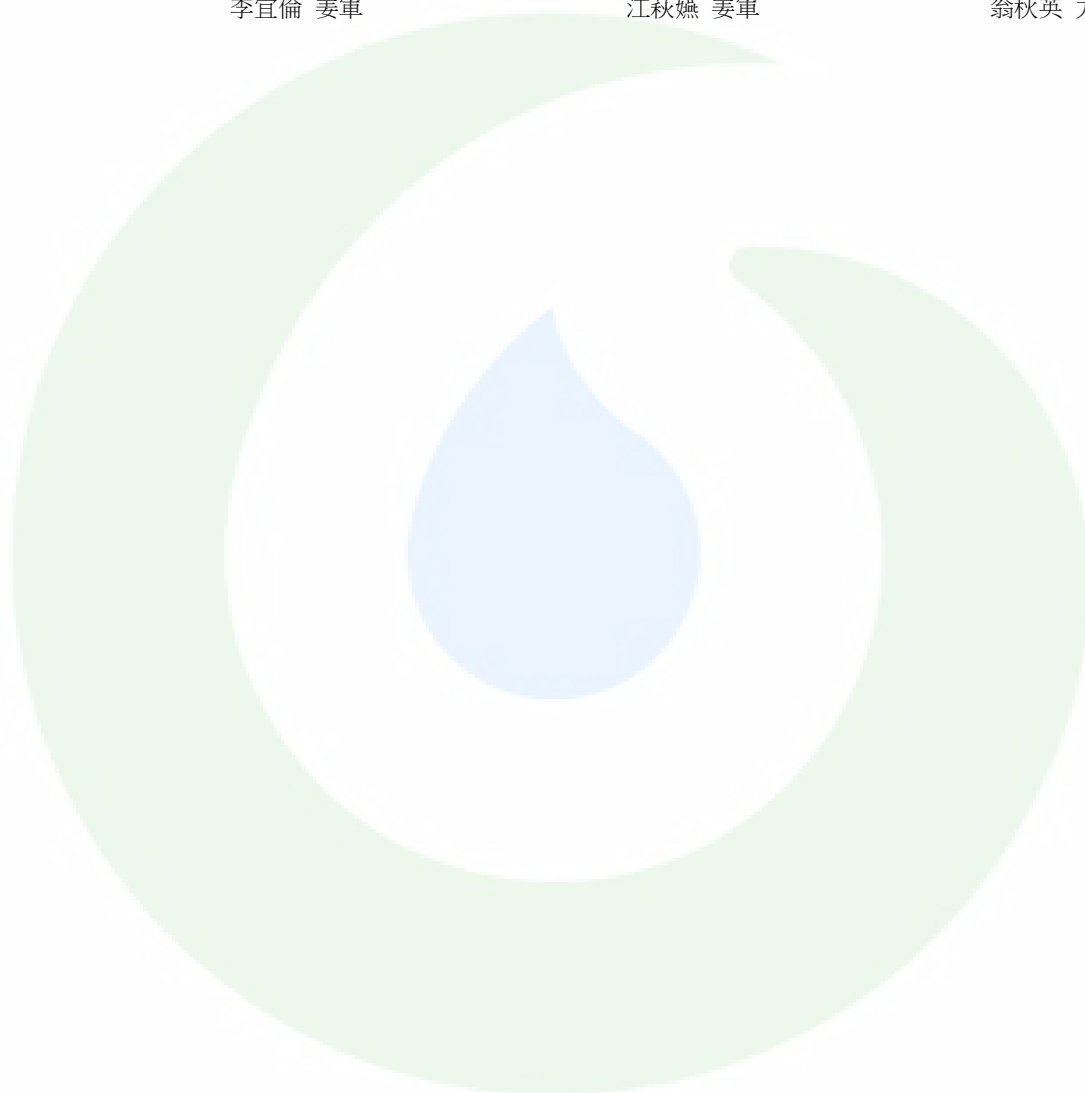
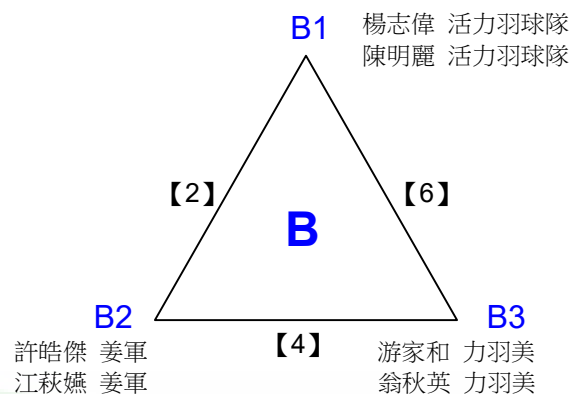
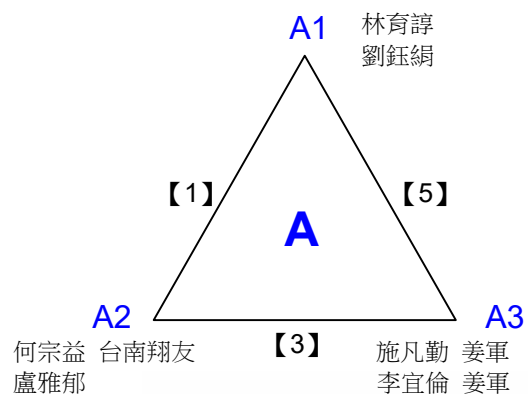

決賽:抽籤決定位置

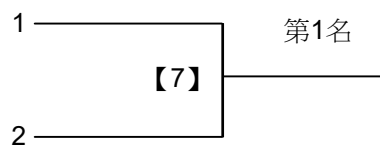

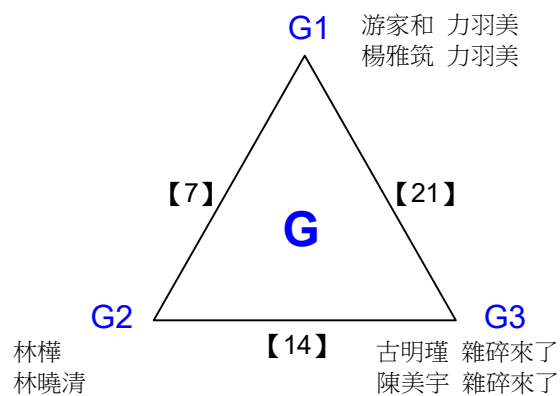
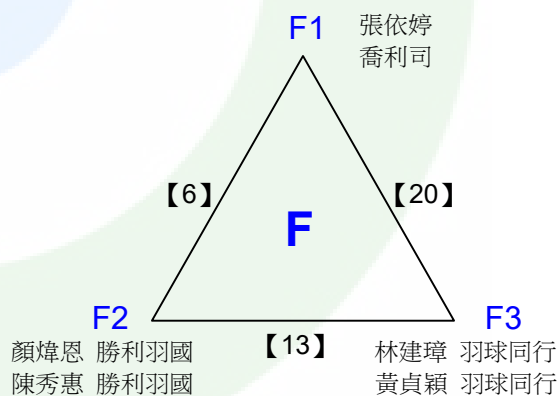
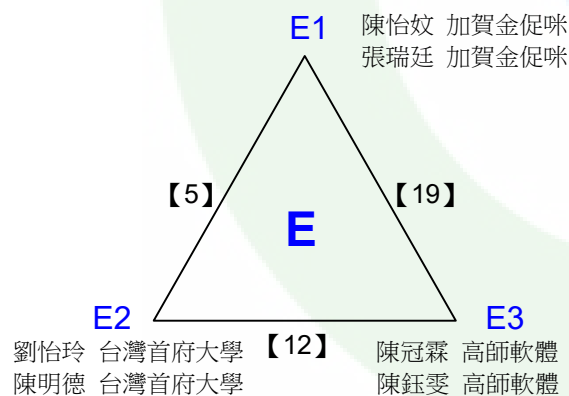
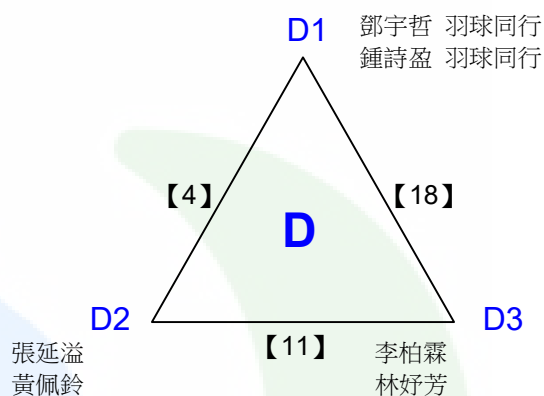
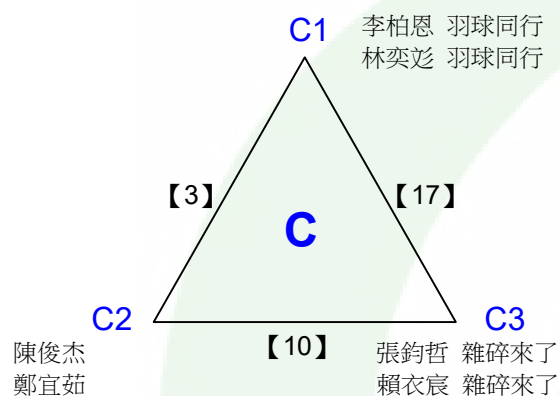
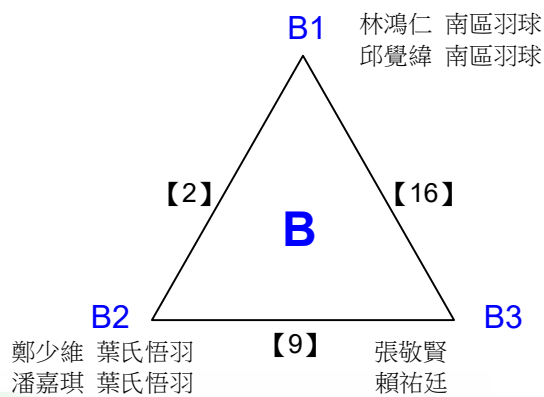
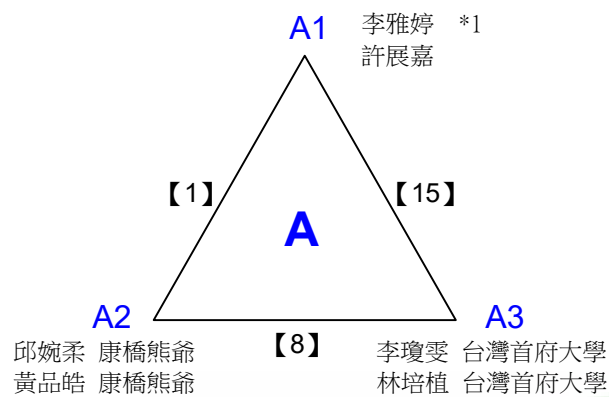

決賽:抽籤決定位置

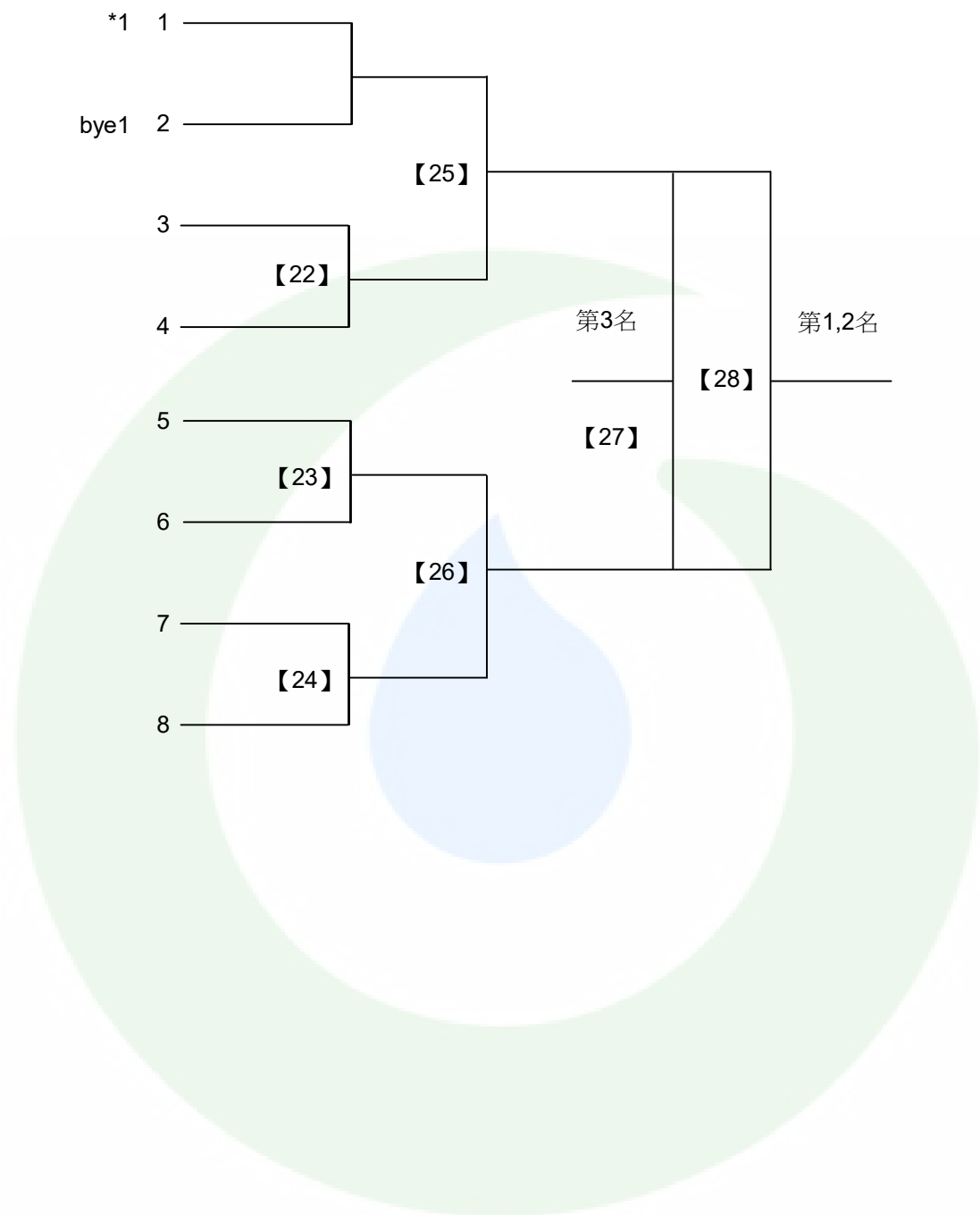

A1 劉賢麒 滾水慈惠醫專 *1

趙士杰 高雄科技大學 周辰諭 國立雲林科技大學

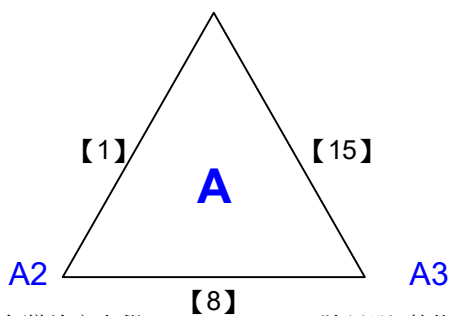

胡育誠 台灣首府大學 陳邑明 萬能科技大學

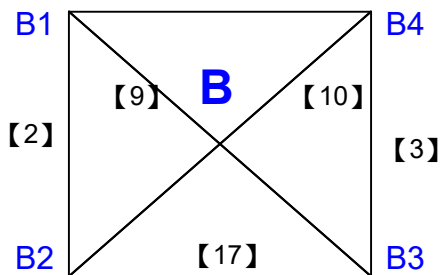

吳柏仁 高苑科大 陳威宇 銘傳大學 (傑章工業)

徐國祐 滾水慈惠醫專 熊禹豪 國立高雄餐旅大學

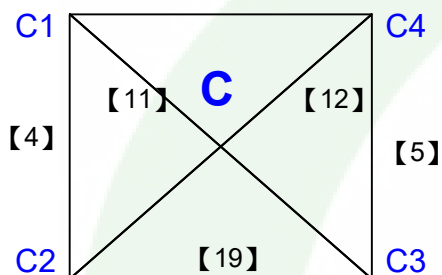

廖文弘 美和科技大學 林哲孝 高苑科大

D1 黃智群 美和科技大學

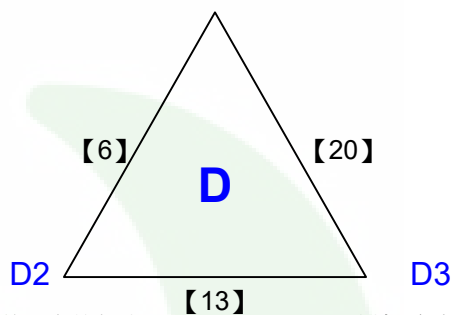

陳觀詠 普羅高雄師大 呂陳楨 滾水慈惠醫專

E1 陳冠霖 高師軟體

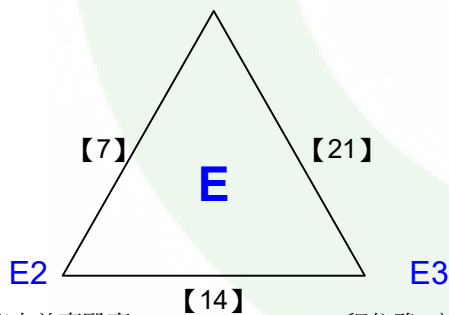

潘原 滾水慈惠醫專 程信豫 高苑科大

決賽:抽籤決定位置

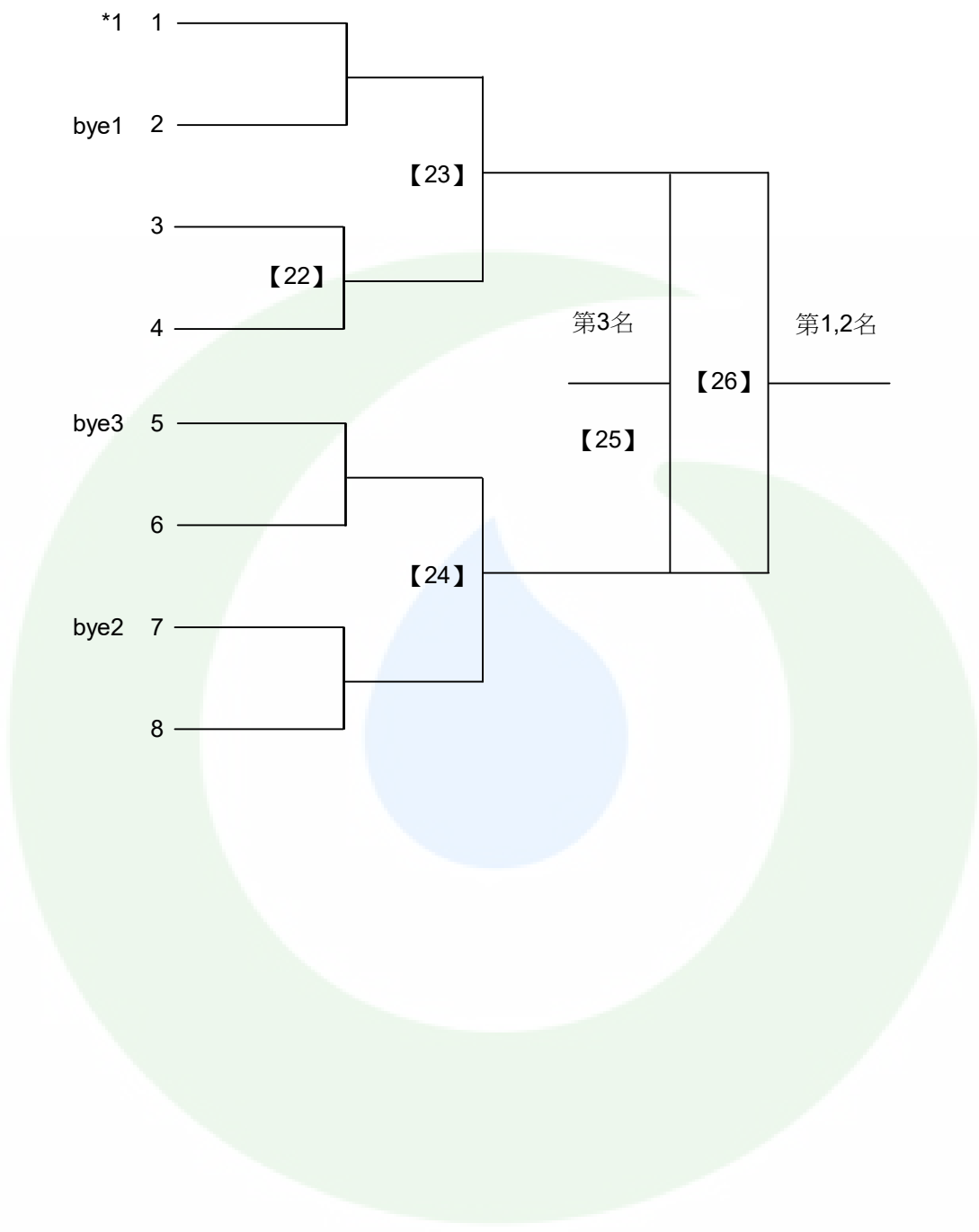

取2名

共7籤

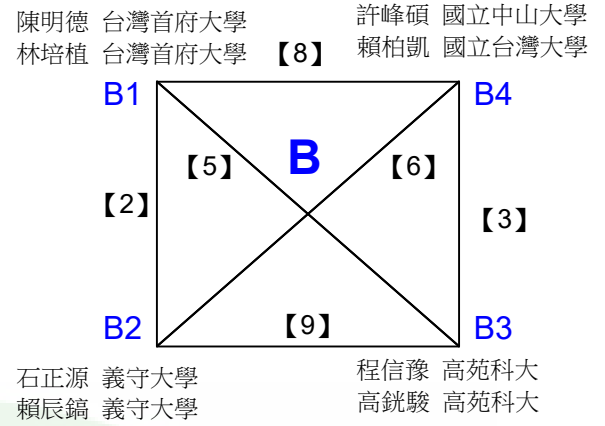
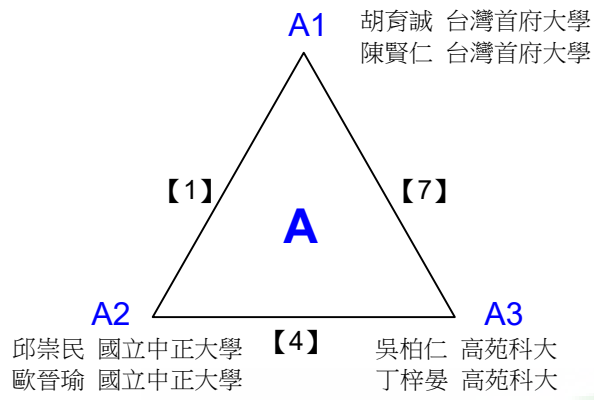

決賽:抽籤決定位置

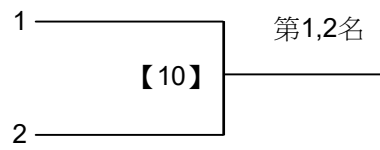

郭于甄 國立台南大學

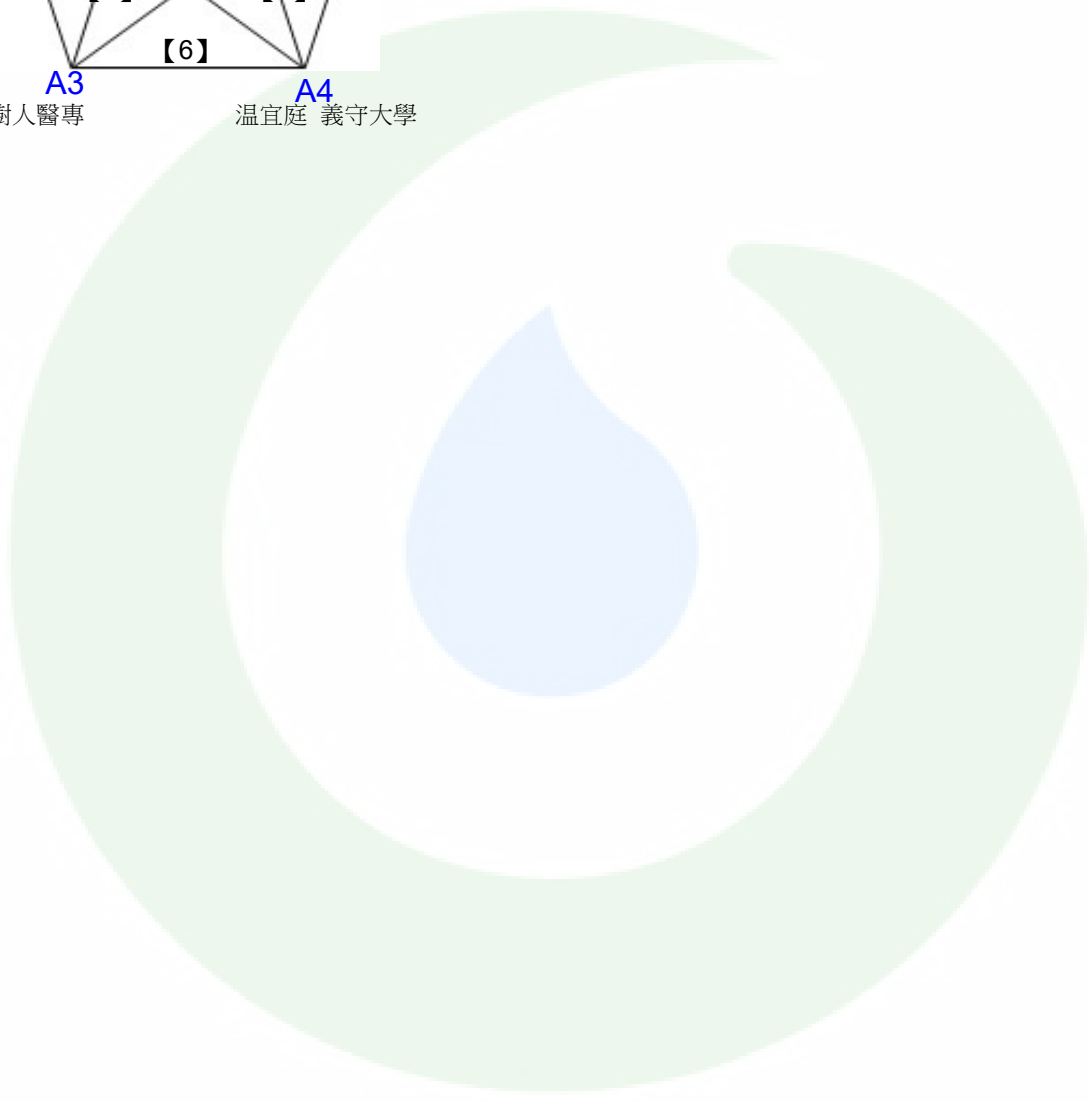
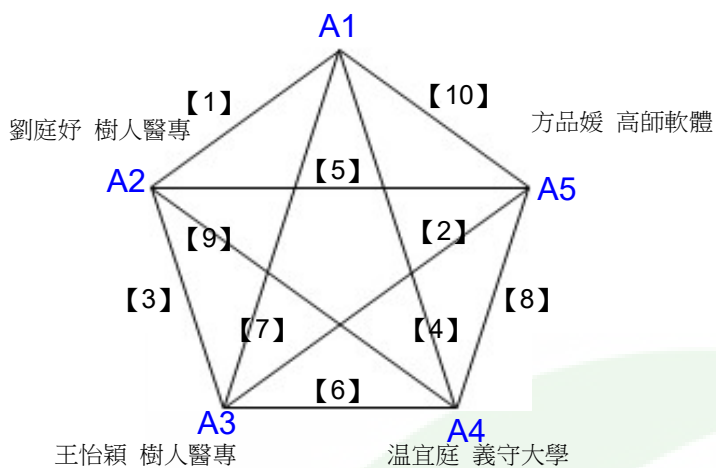

曹承恩

陳威辛

【13】

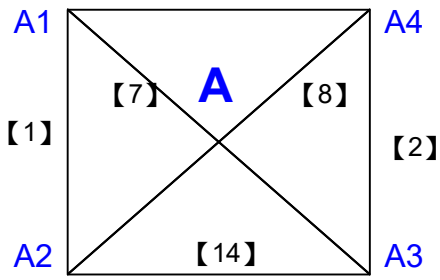

林京霆 枋寮高中

鄭鈞蔚

B1

黃冠銘 亞柏雄中

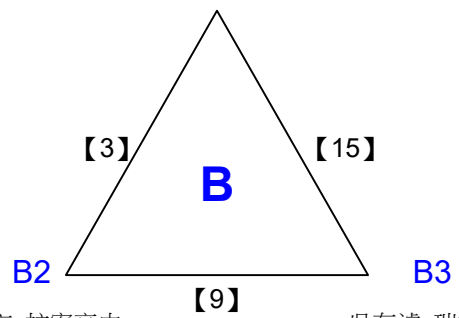

劉俊言 枋寮高中

吳存濬 瑞祥高中

熊維斌 枋寮高中

周沁翰 仁武高中

【16】

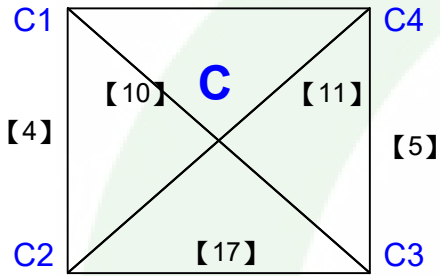

鍾人敬 高雄中學

林子恩 枋寮高中

D1

楊尚仁

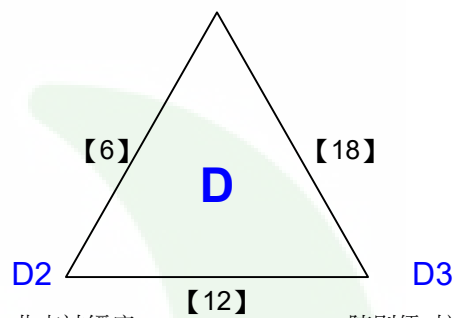

陳麒仁 北屯神經病

陳則儒 枋寮高中

決賽:抽籤決定位置

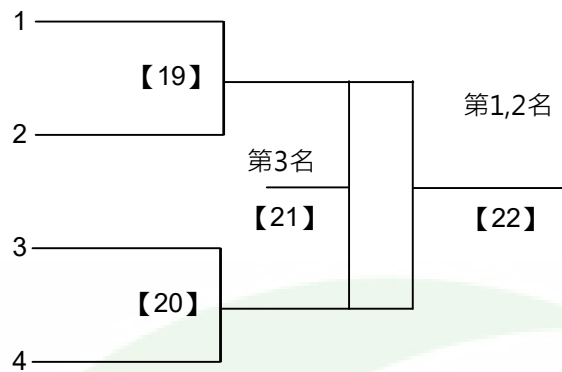

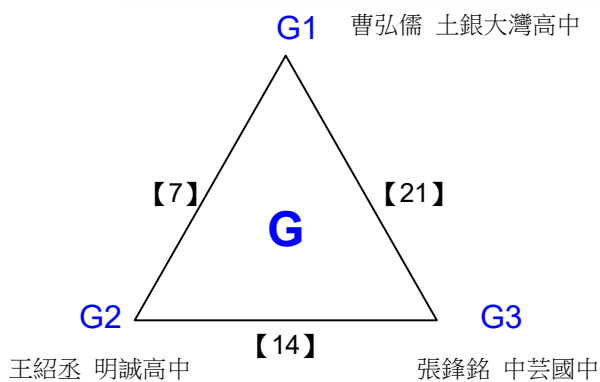
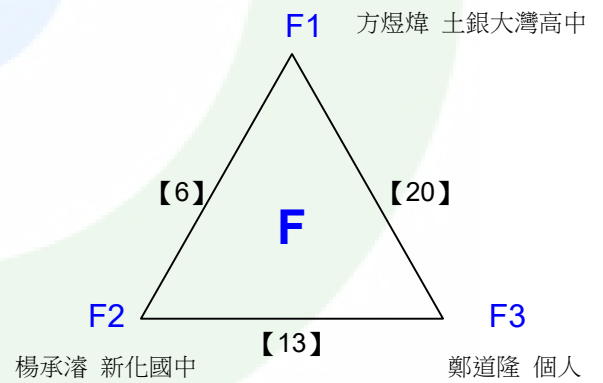
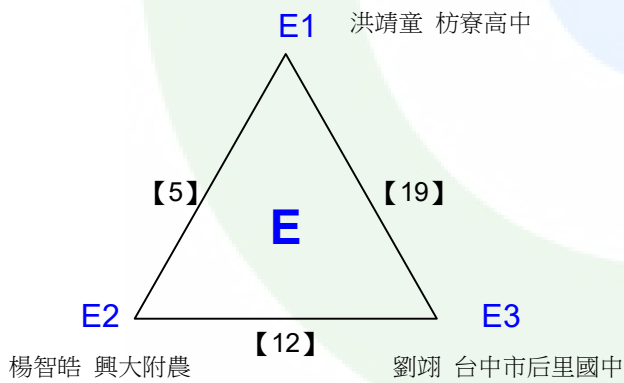
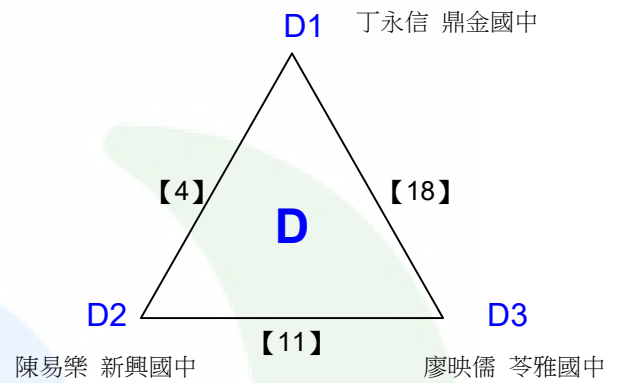
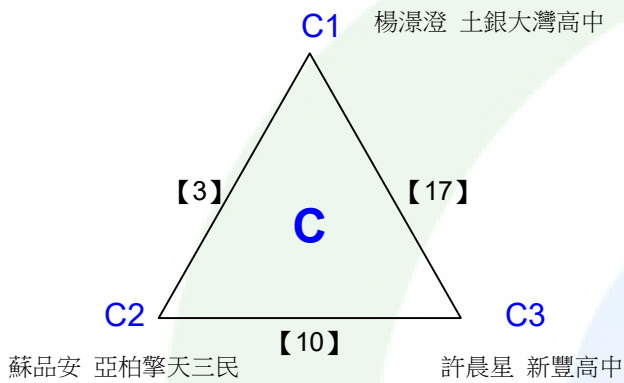
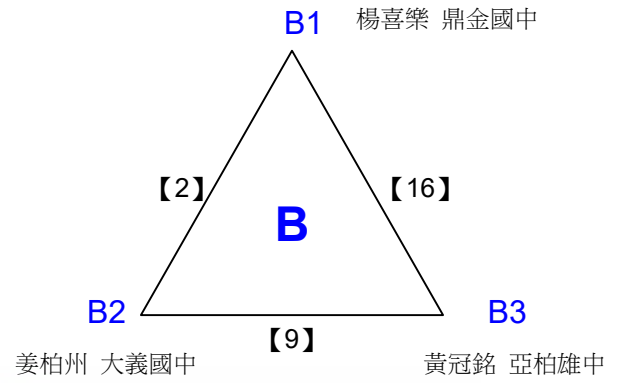
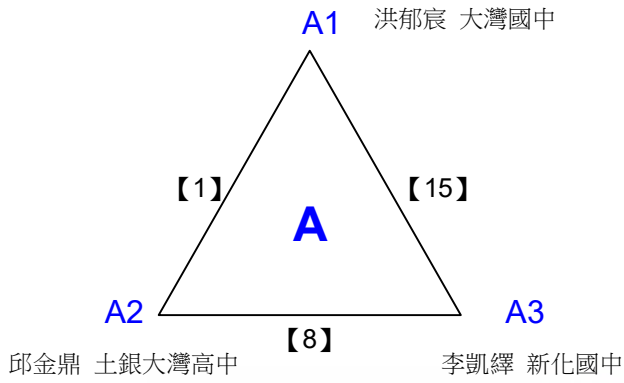

決賽:抽籤決定位置

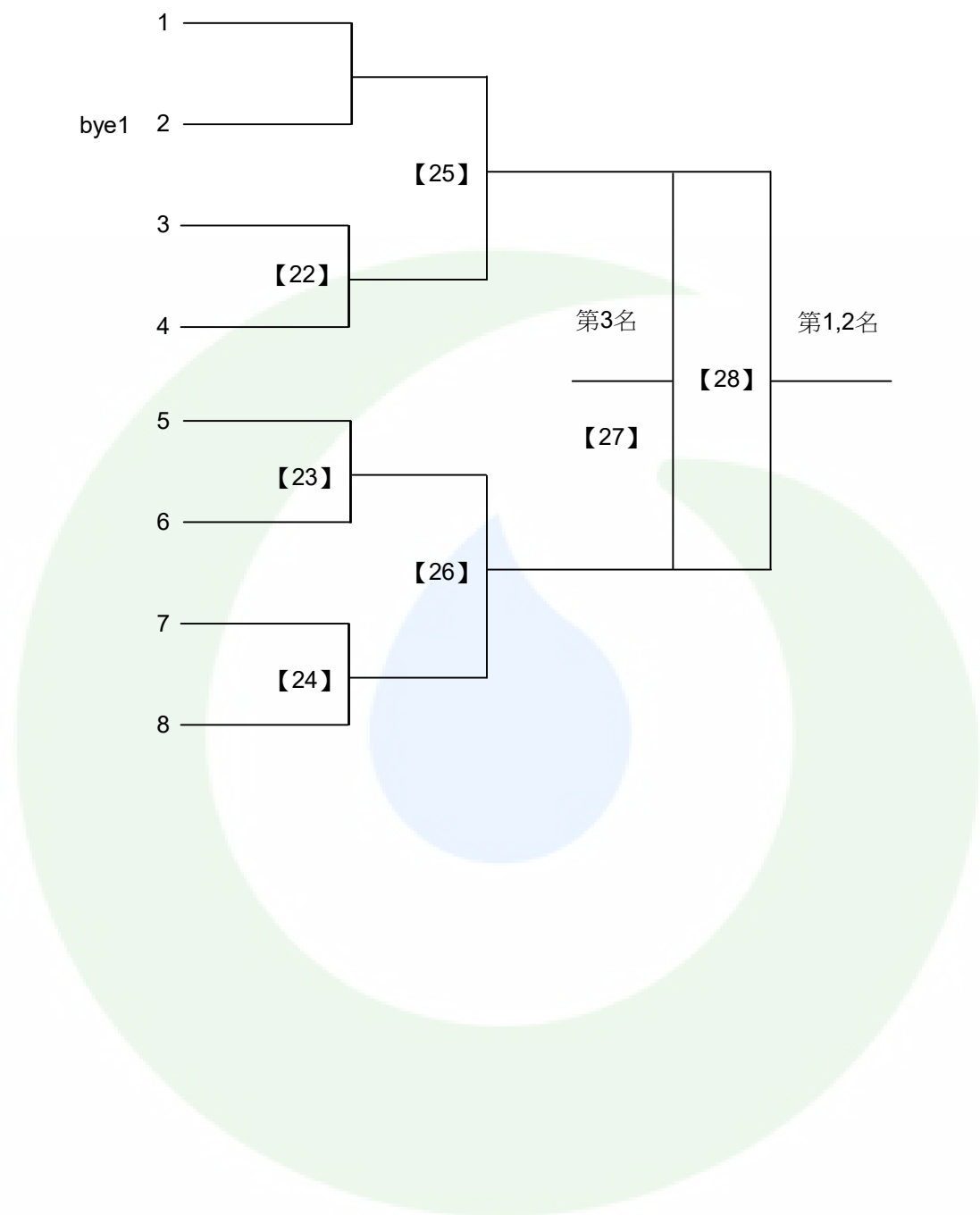

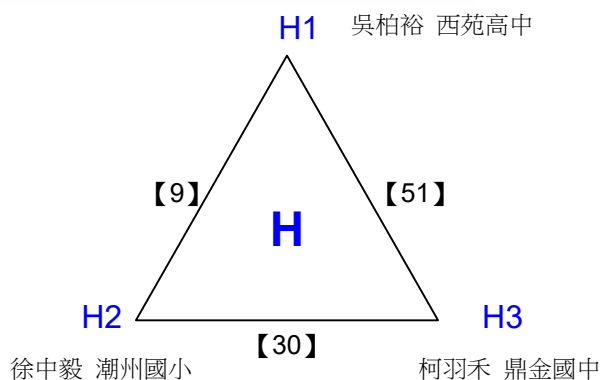
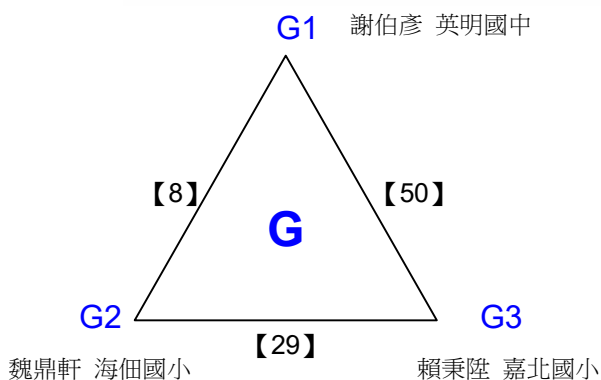
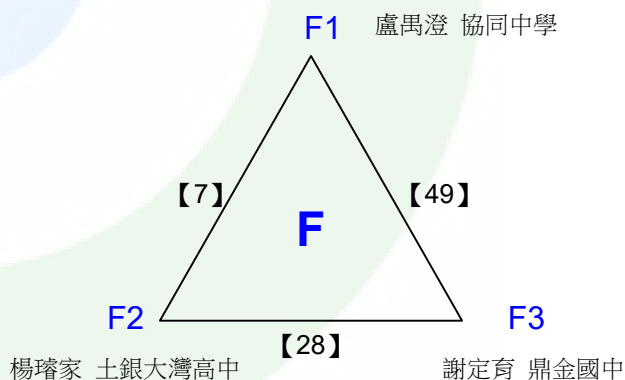
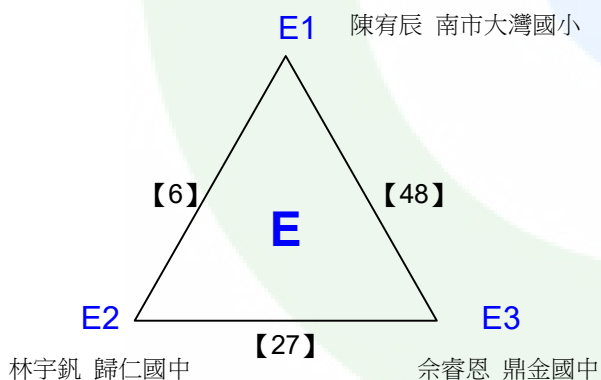
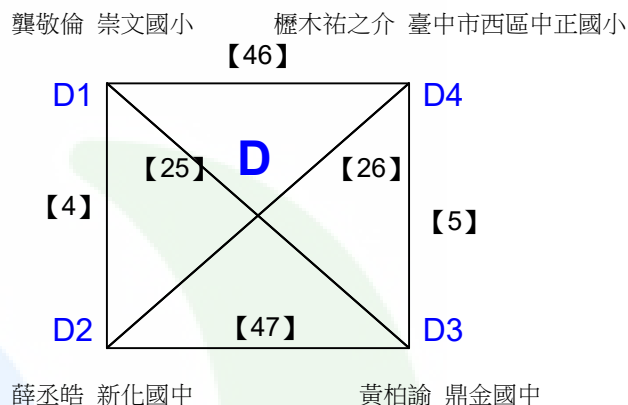
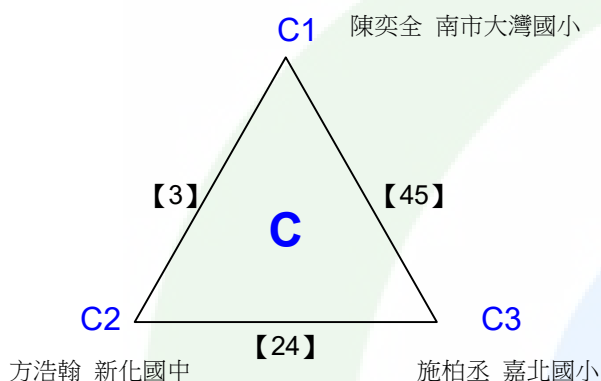
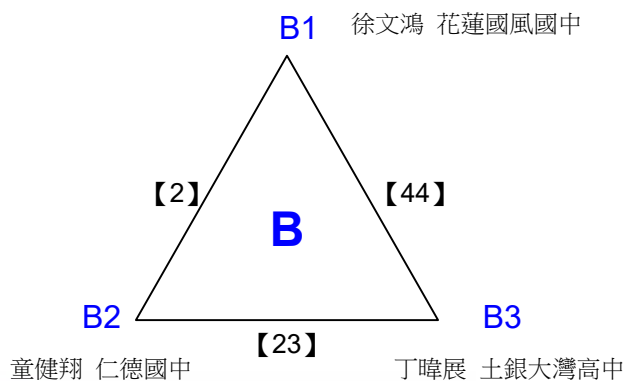
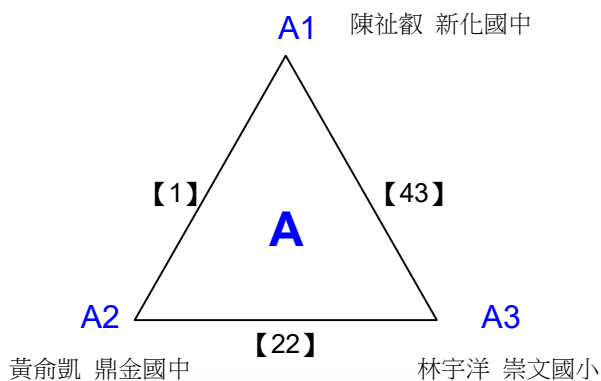

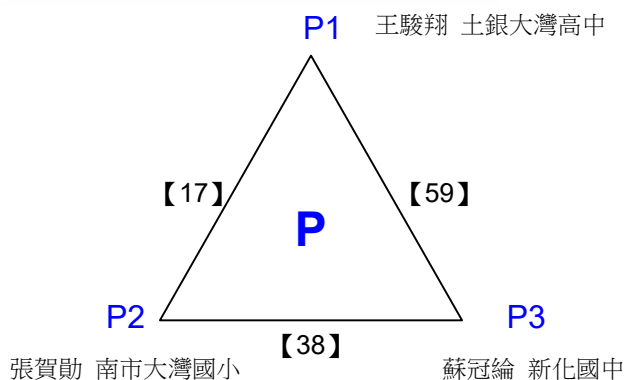
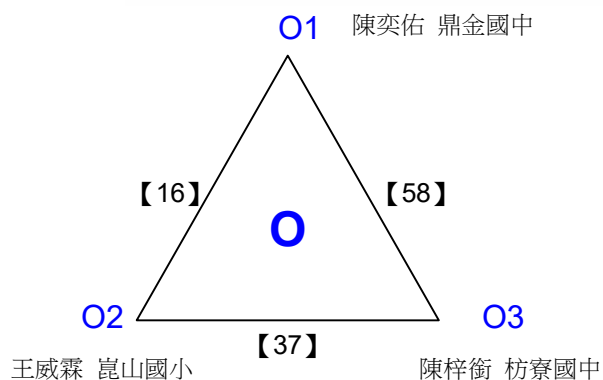
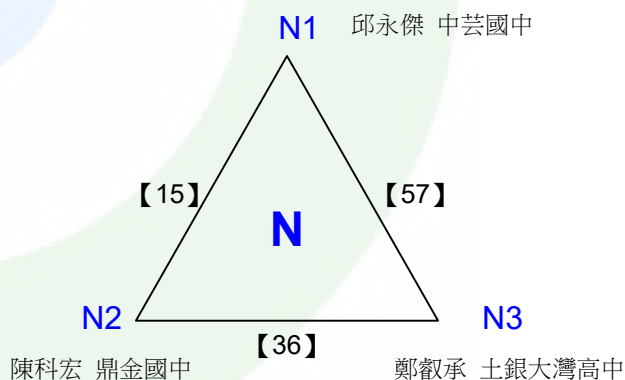
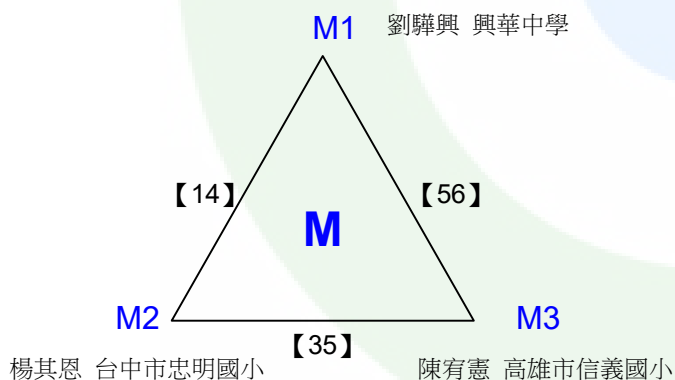
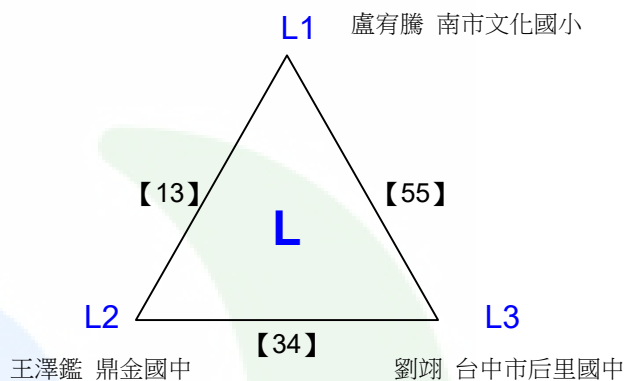
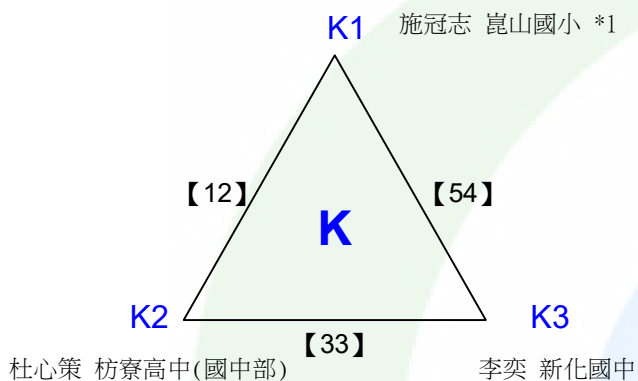
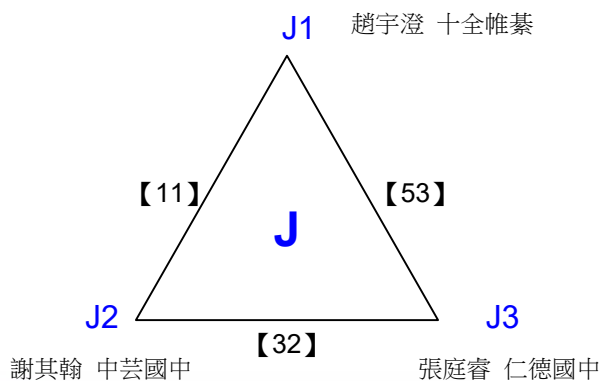
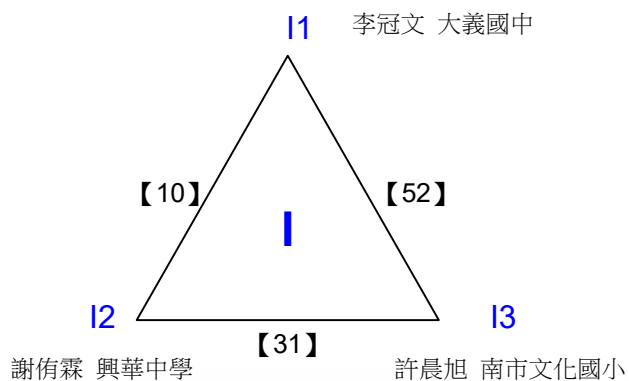

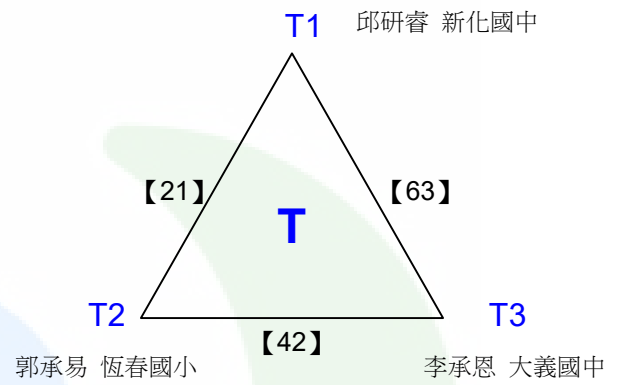
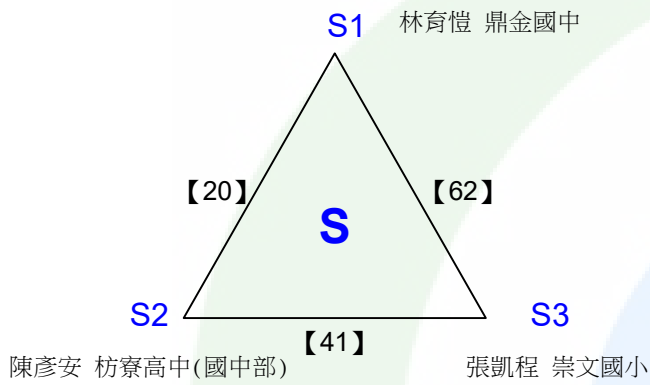
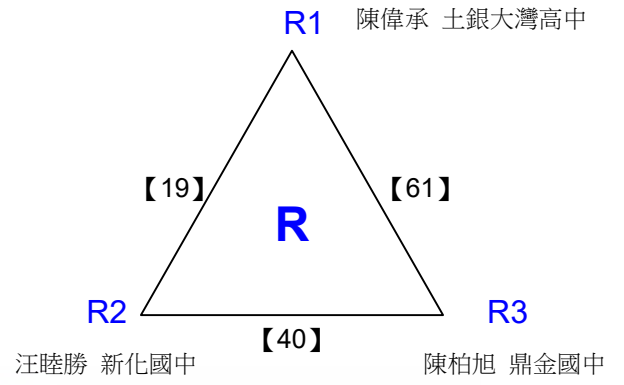
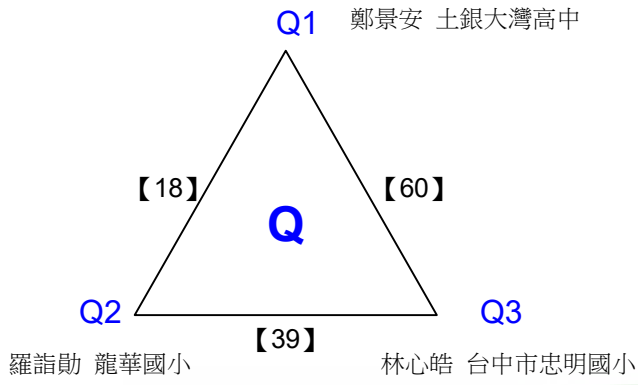

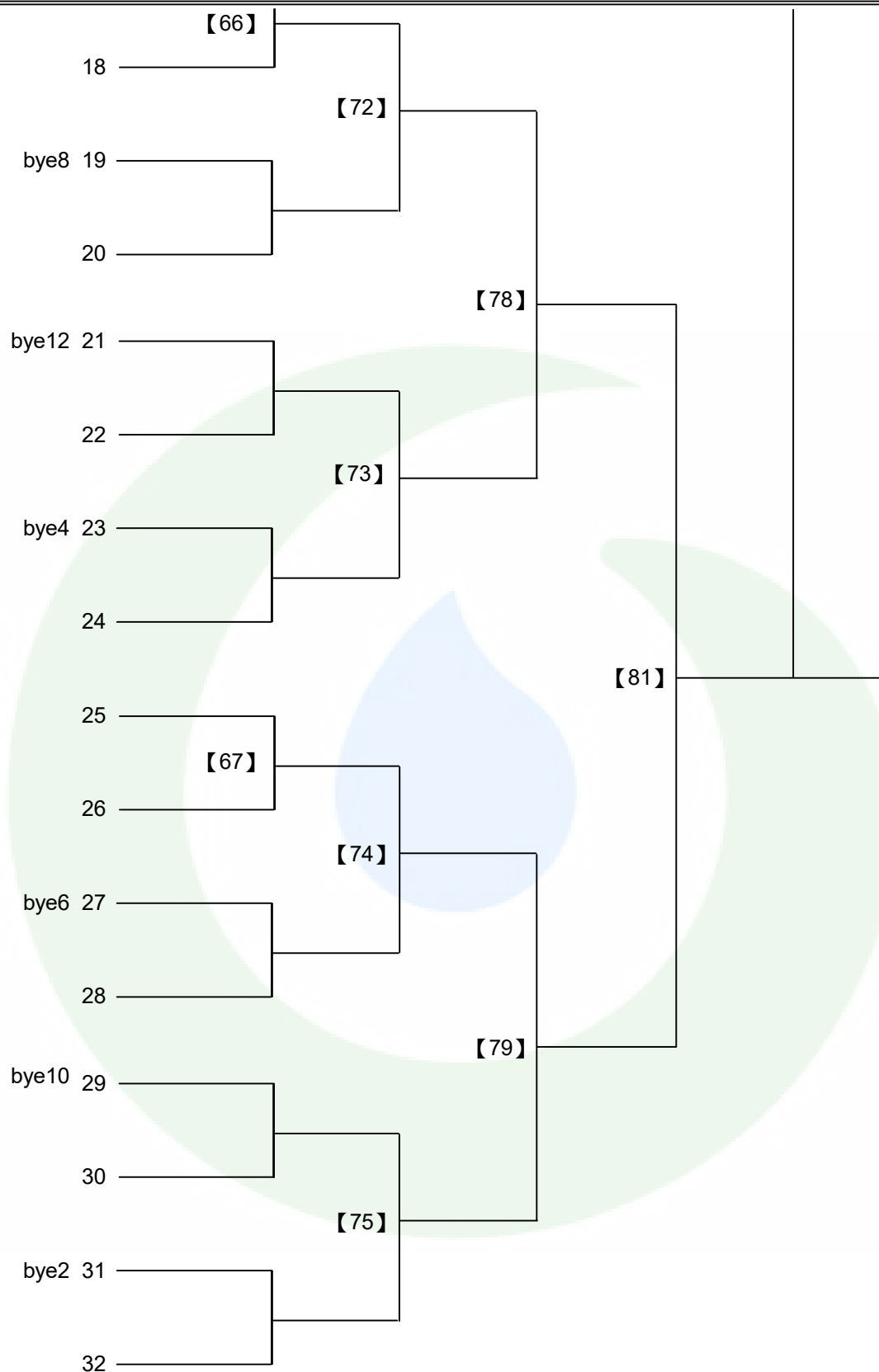

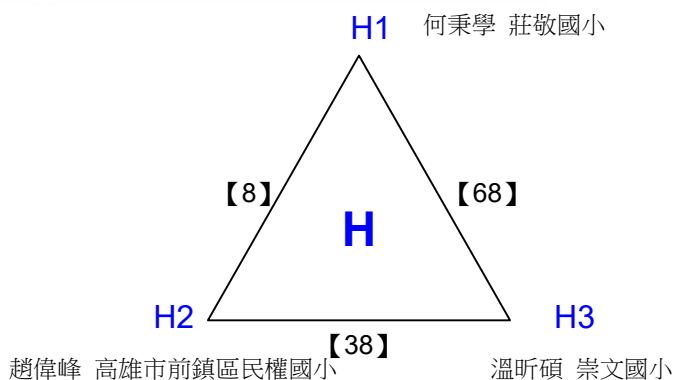
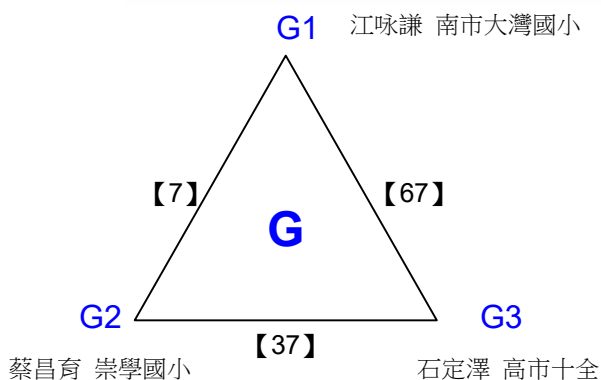
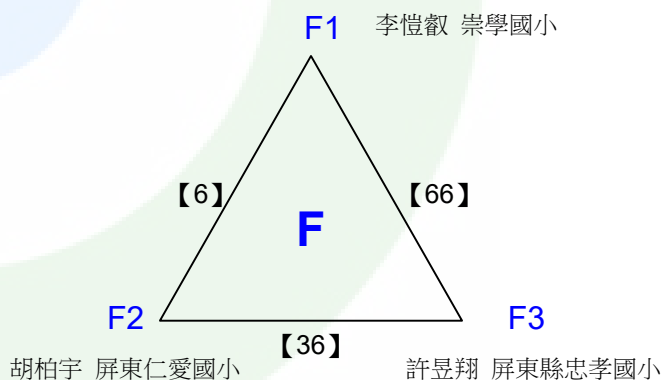
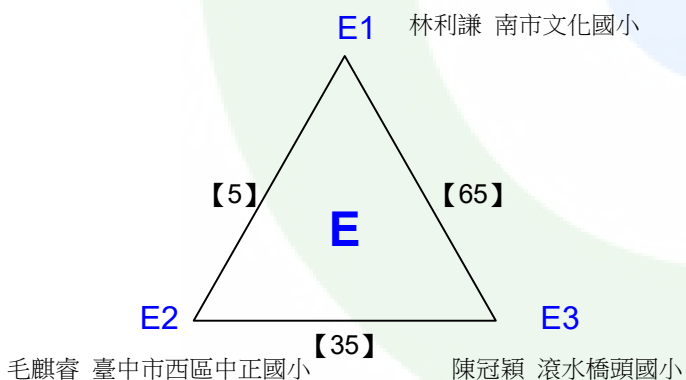
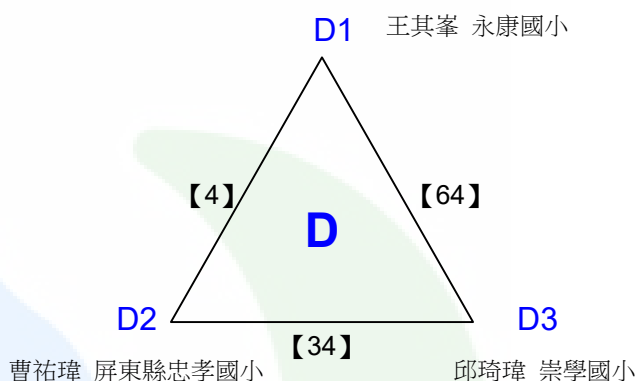
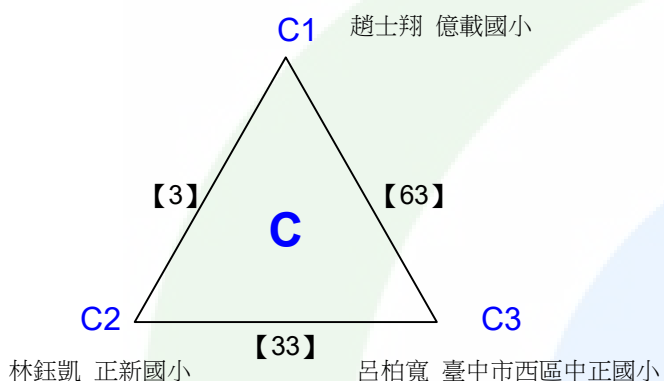
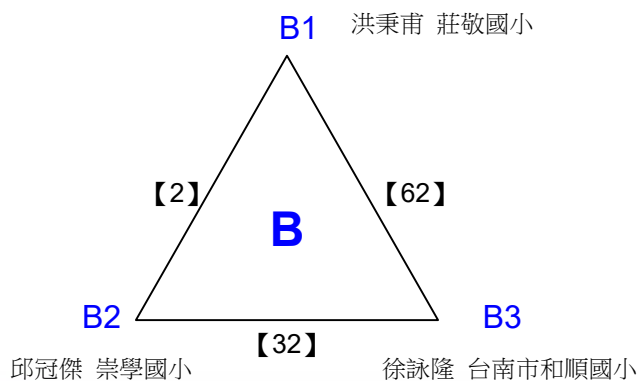
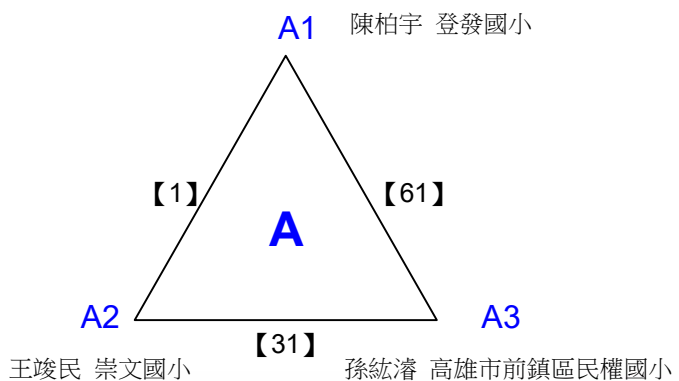

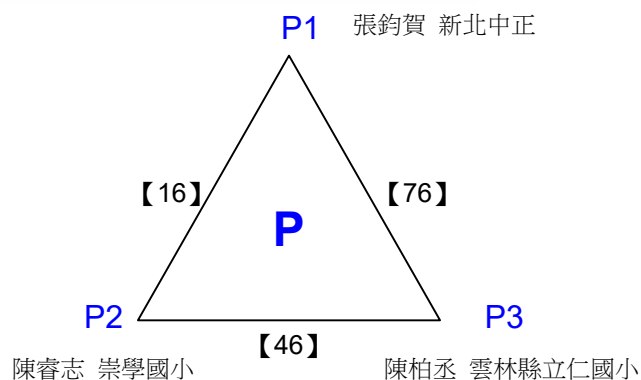
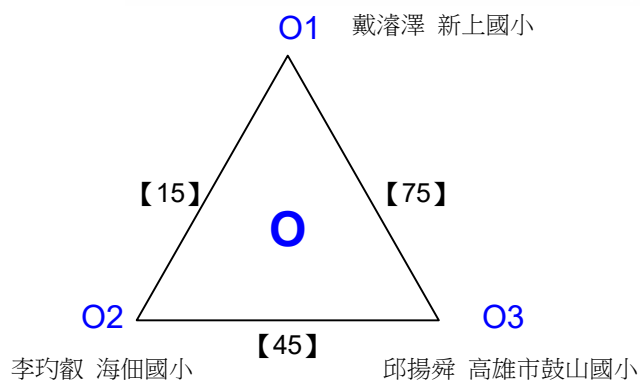
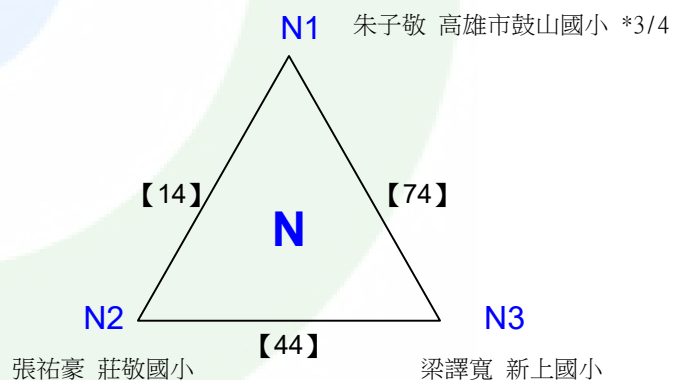
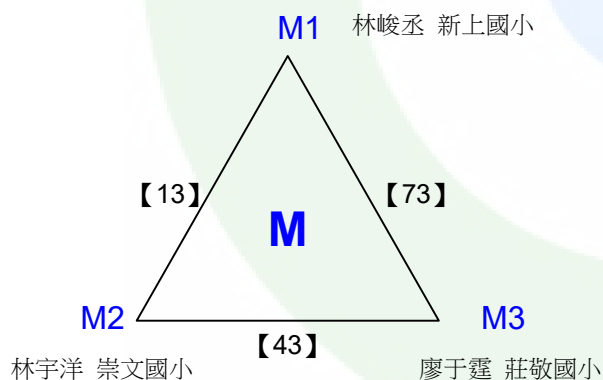
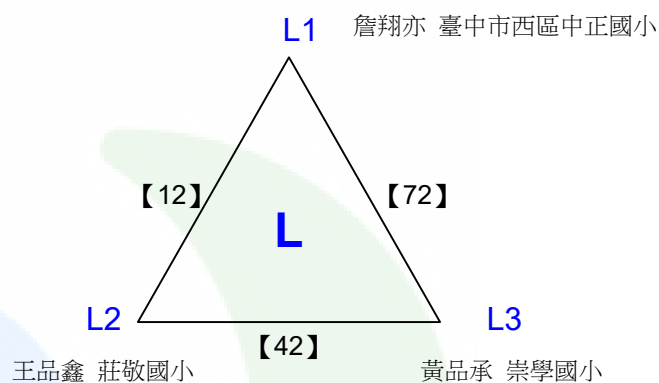
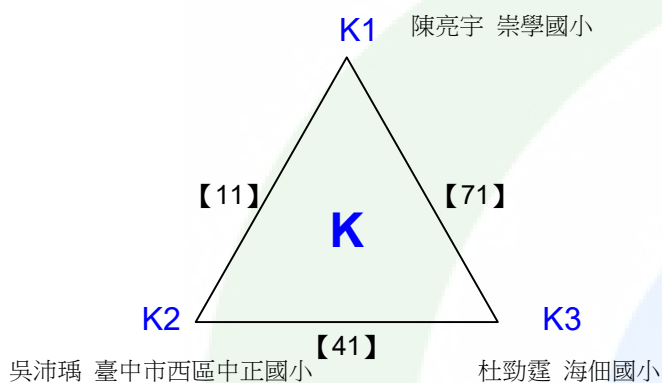
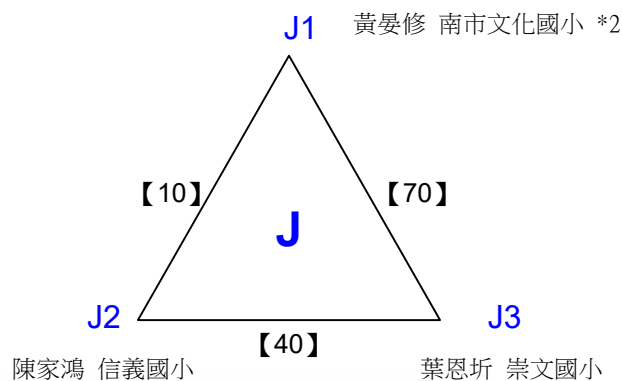
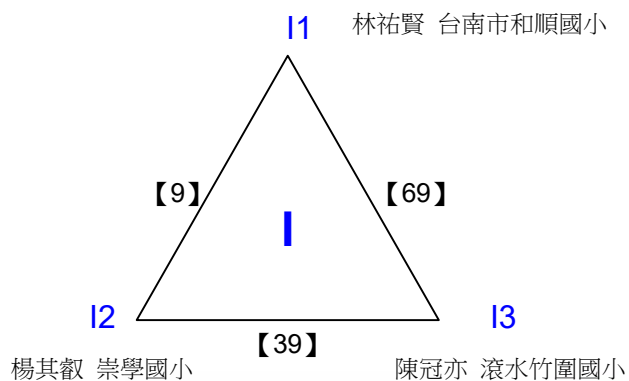

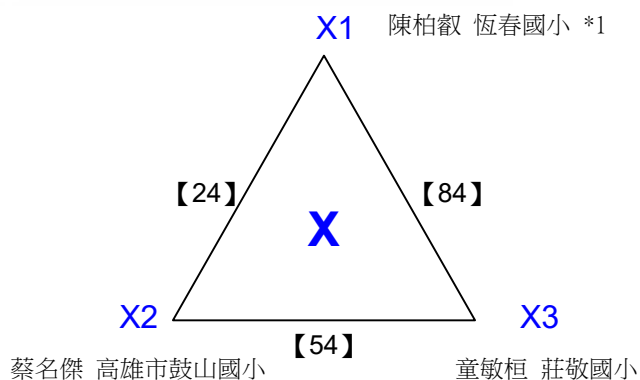
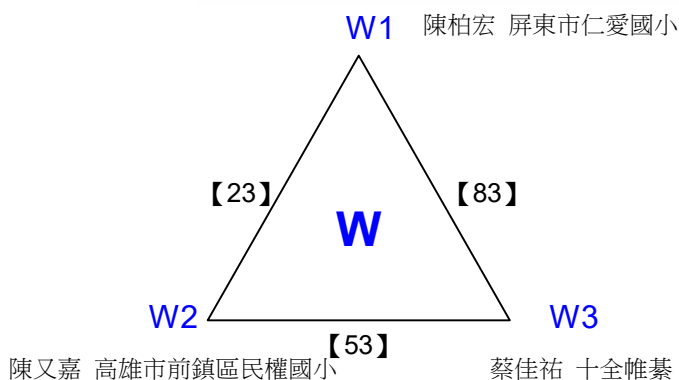
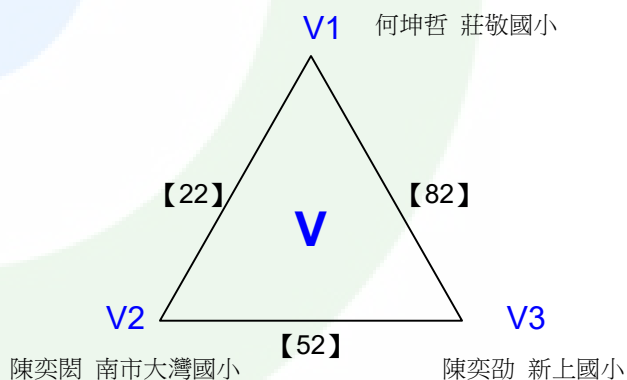
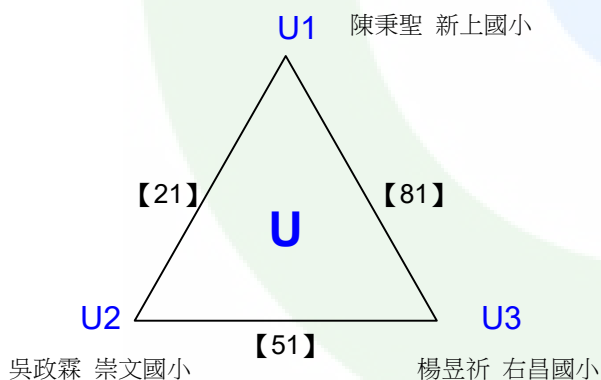
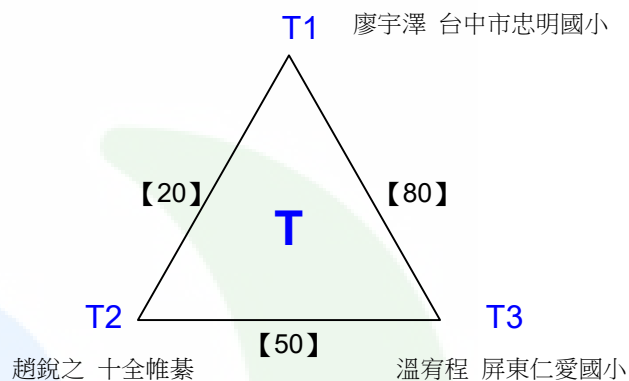
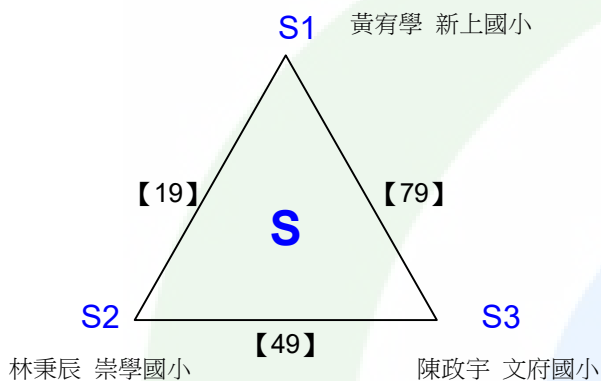
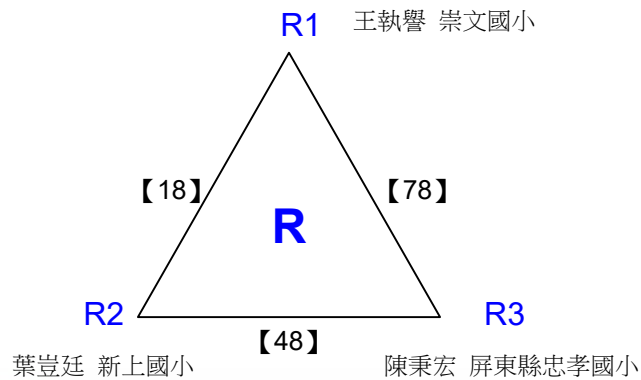
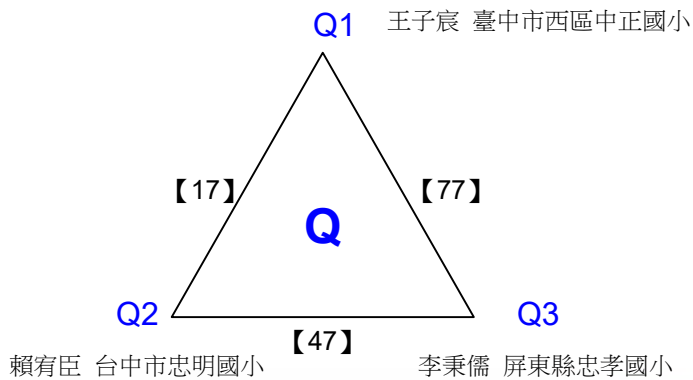

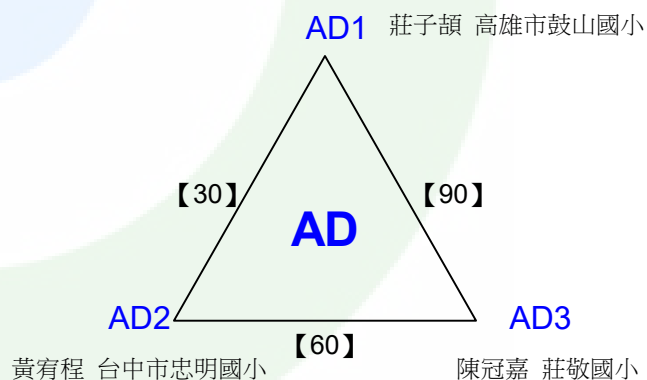
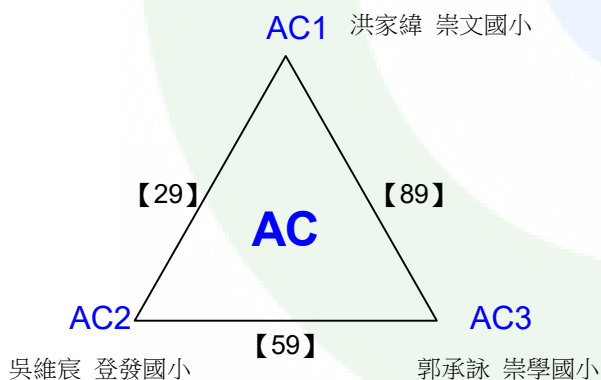
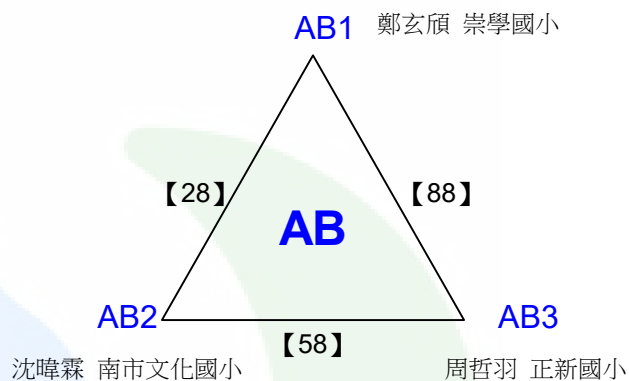
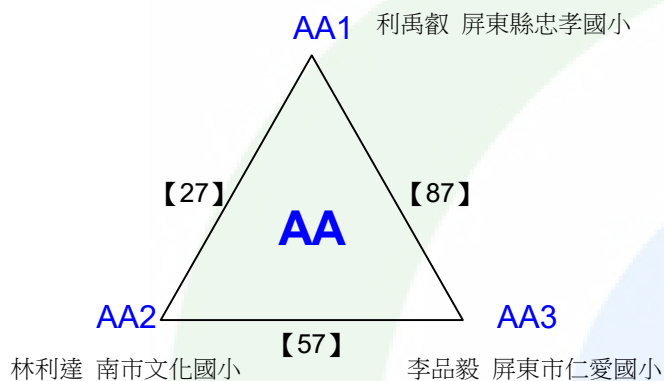
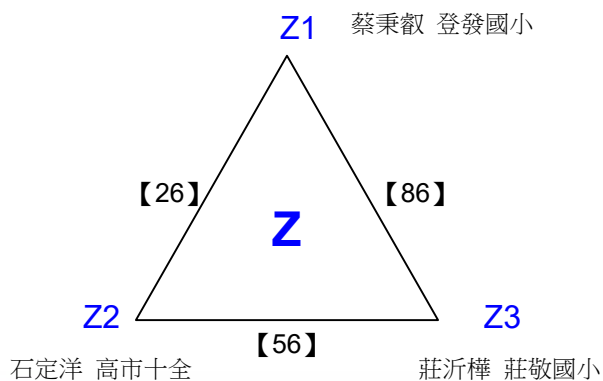
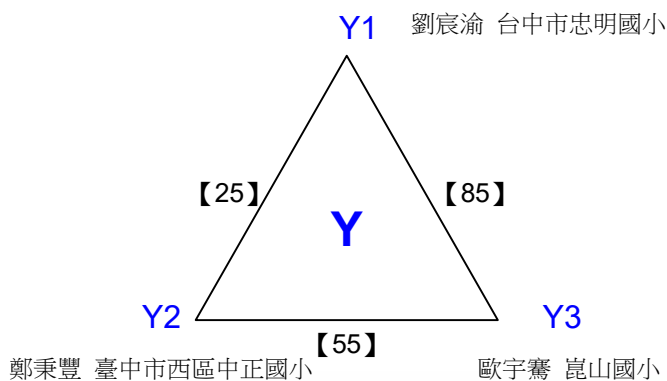

決賽:抽籤決定位置

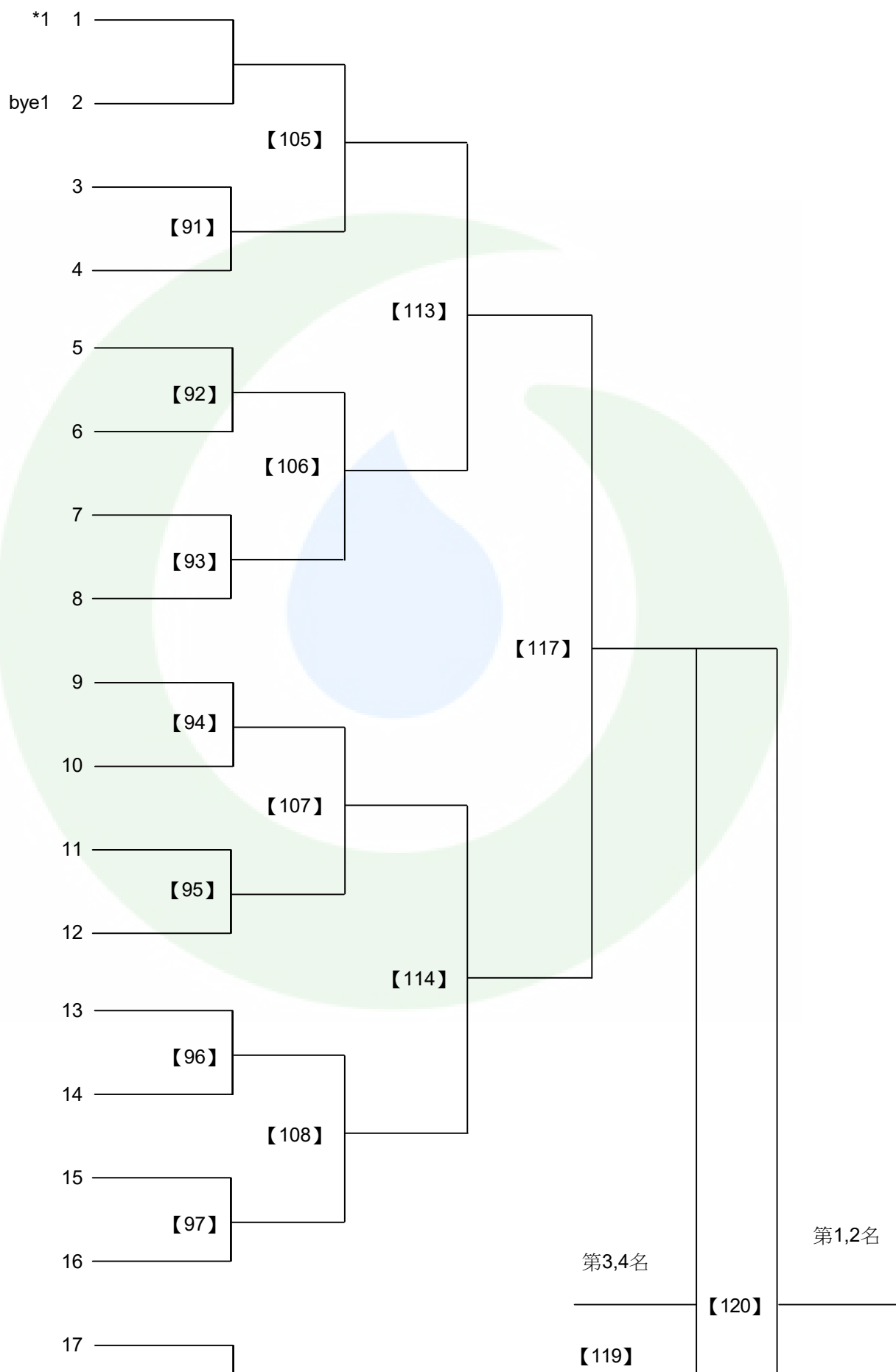

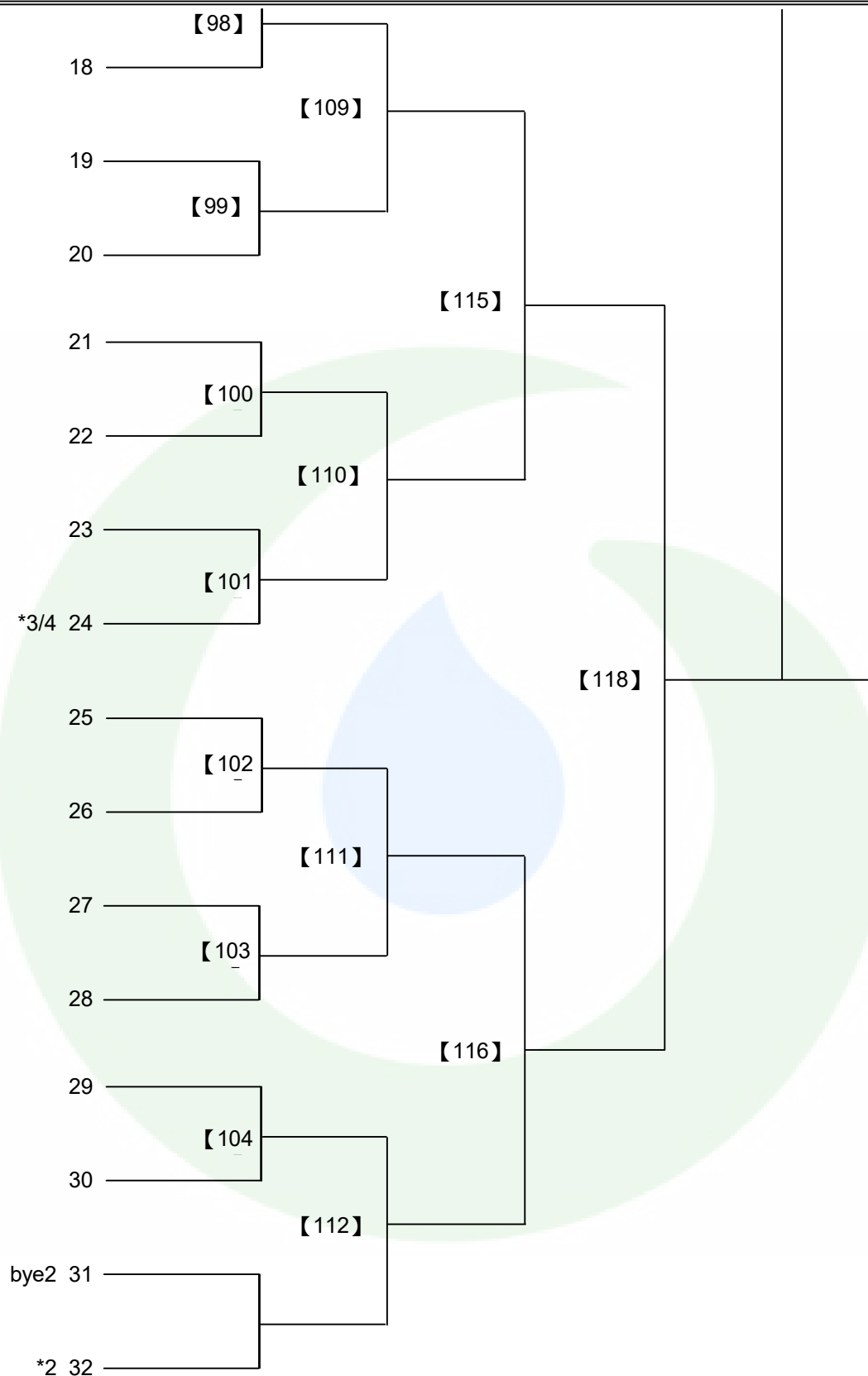

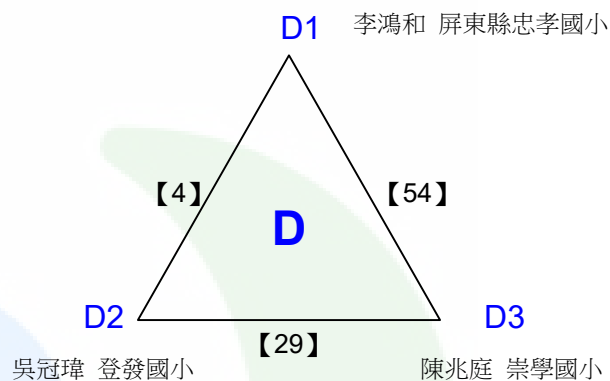
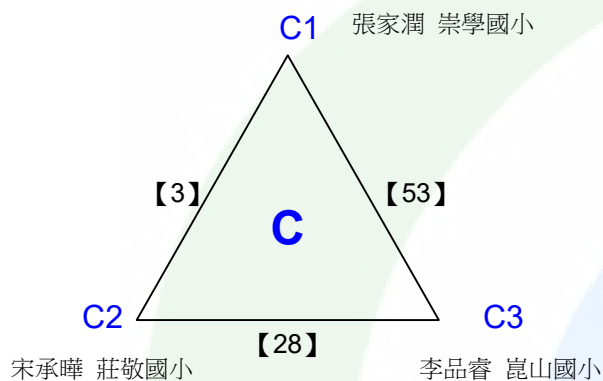
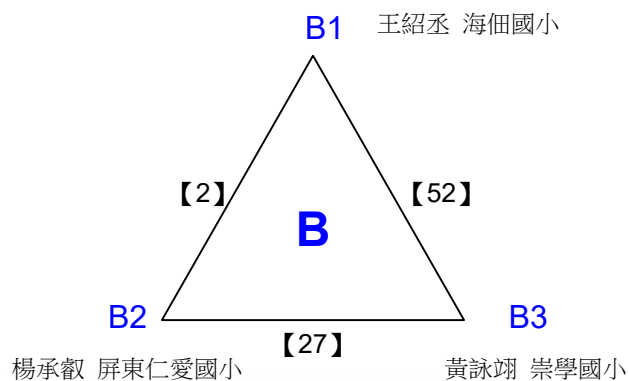
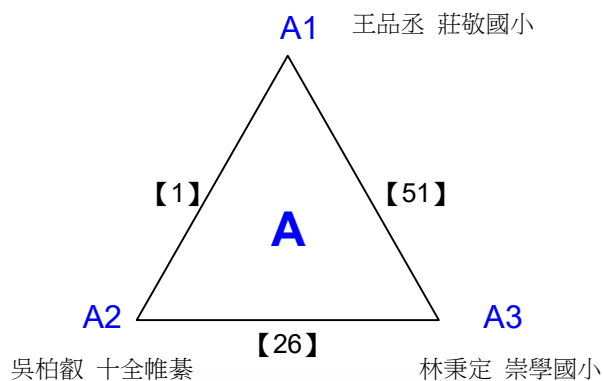

張子毅 高雄市鼓山國小 蘇偉豪 台中市忠明國小

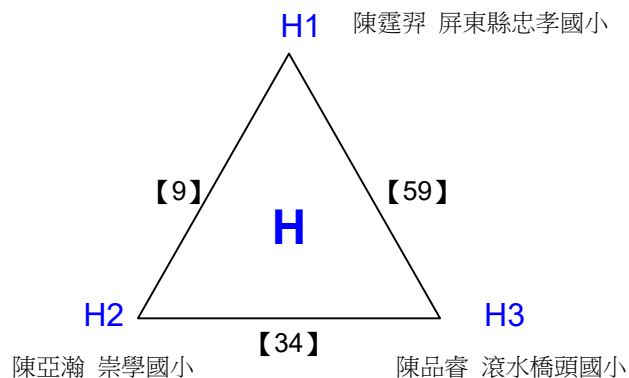
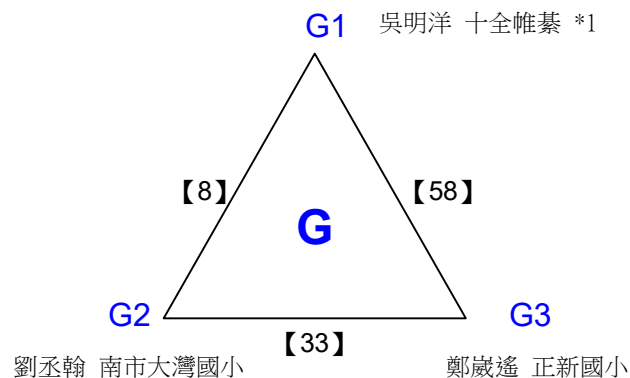
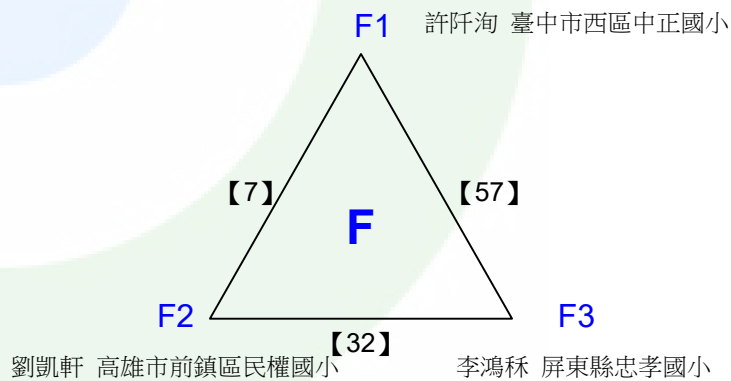
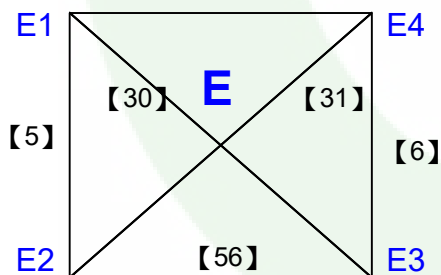

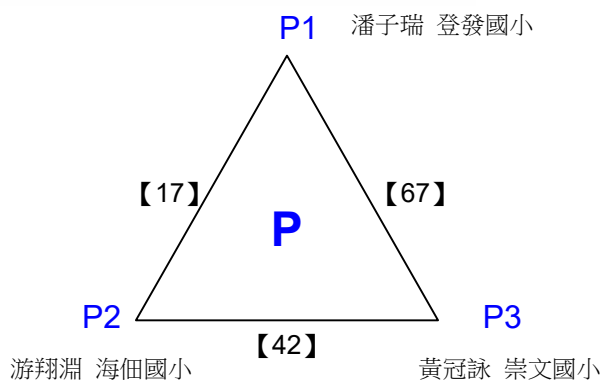
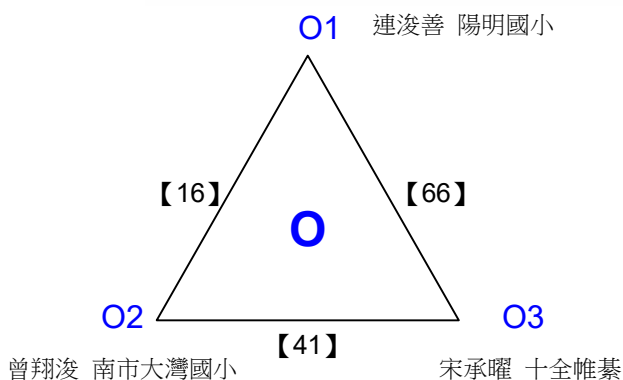
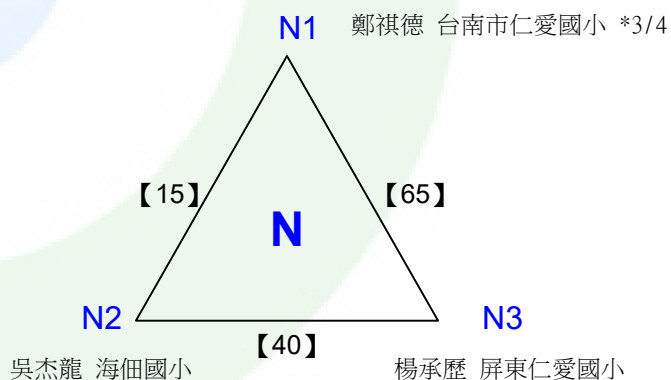
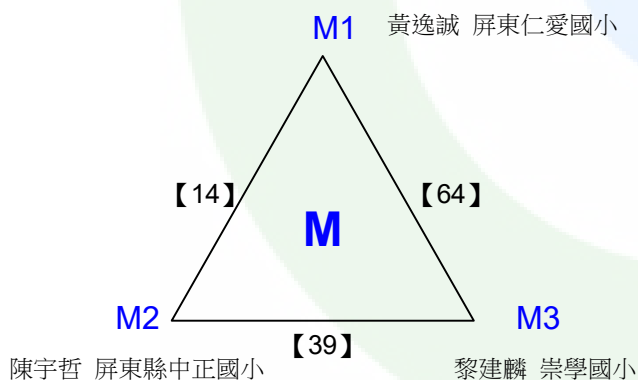
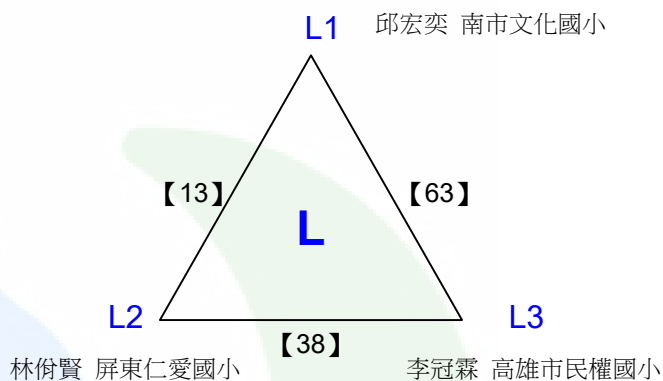
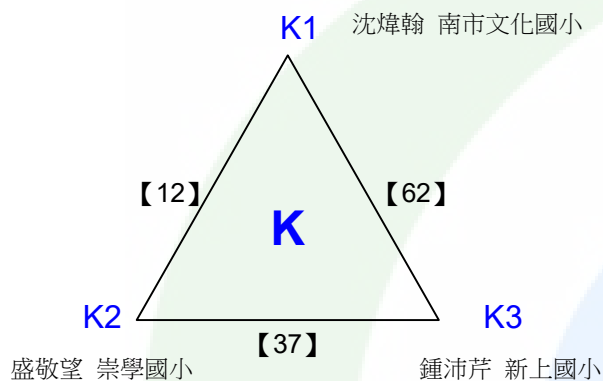
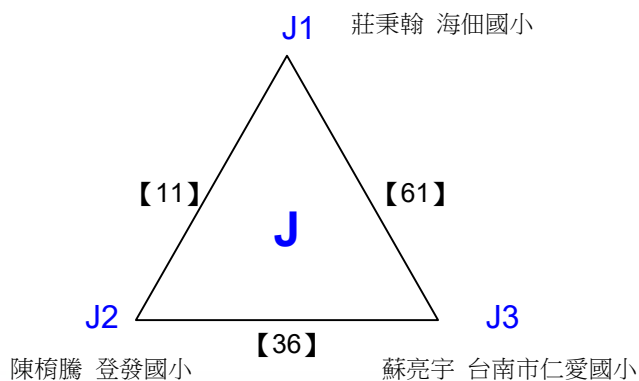
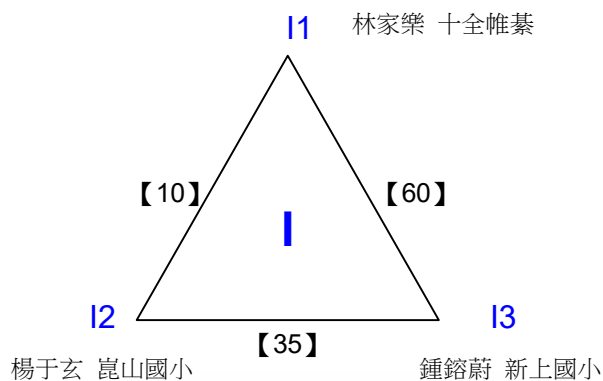

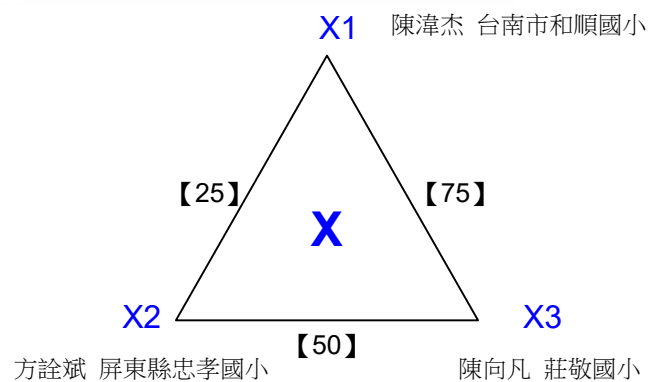
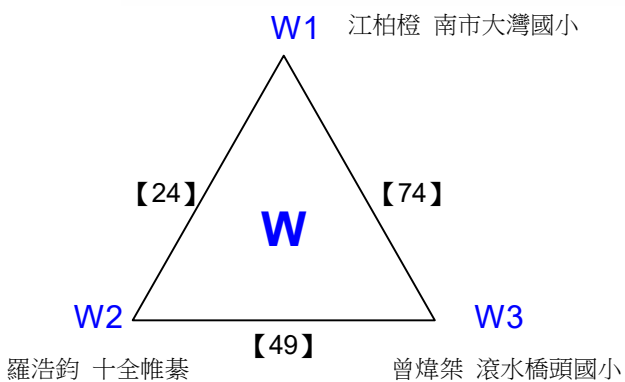
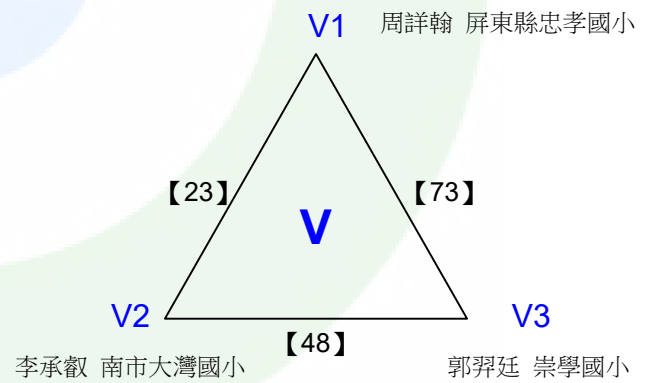
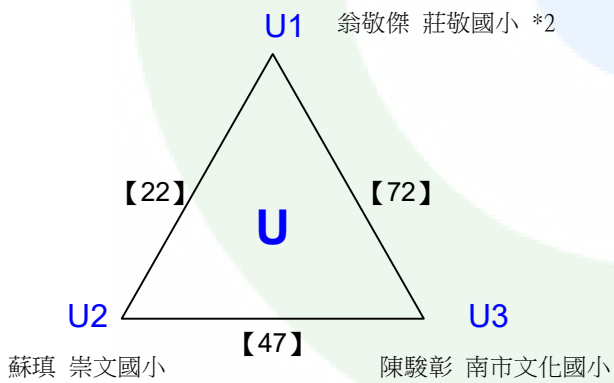
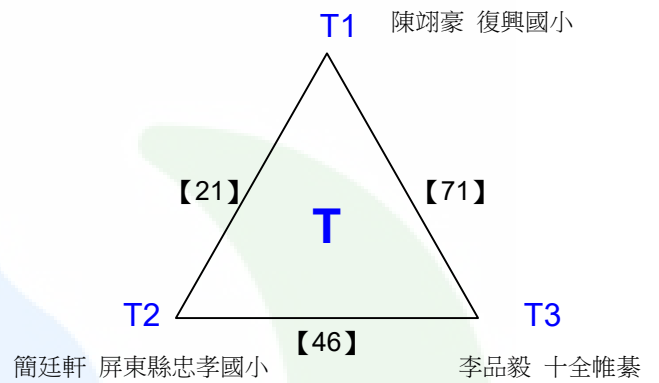
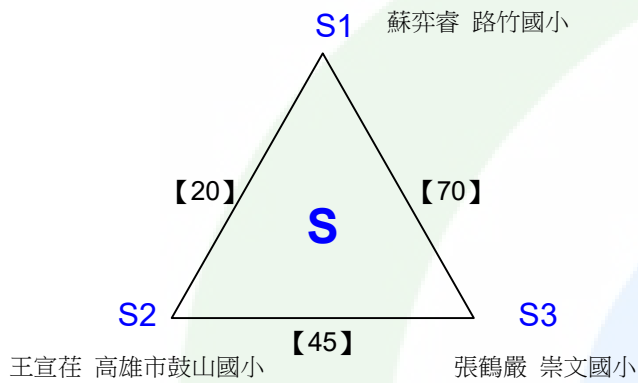
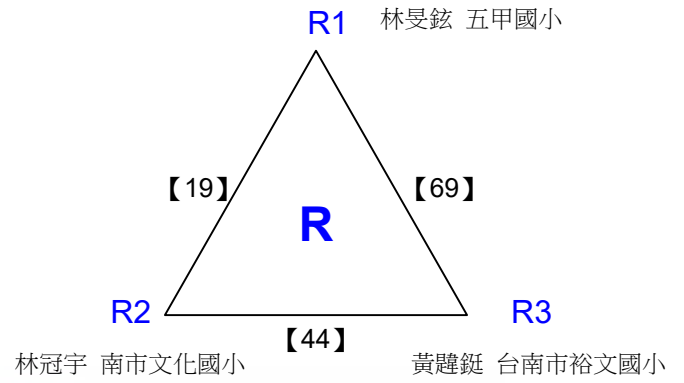
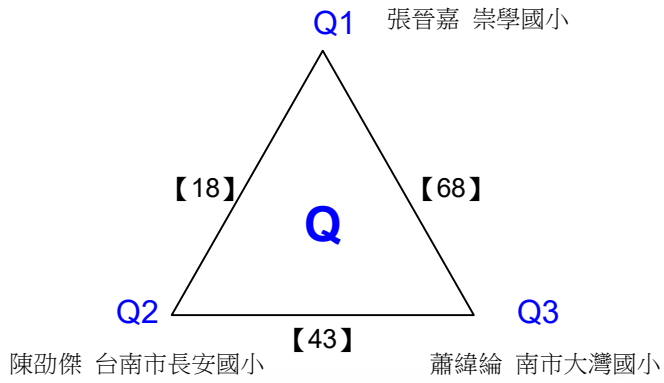

決賽:抽籤決定位置

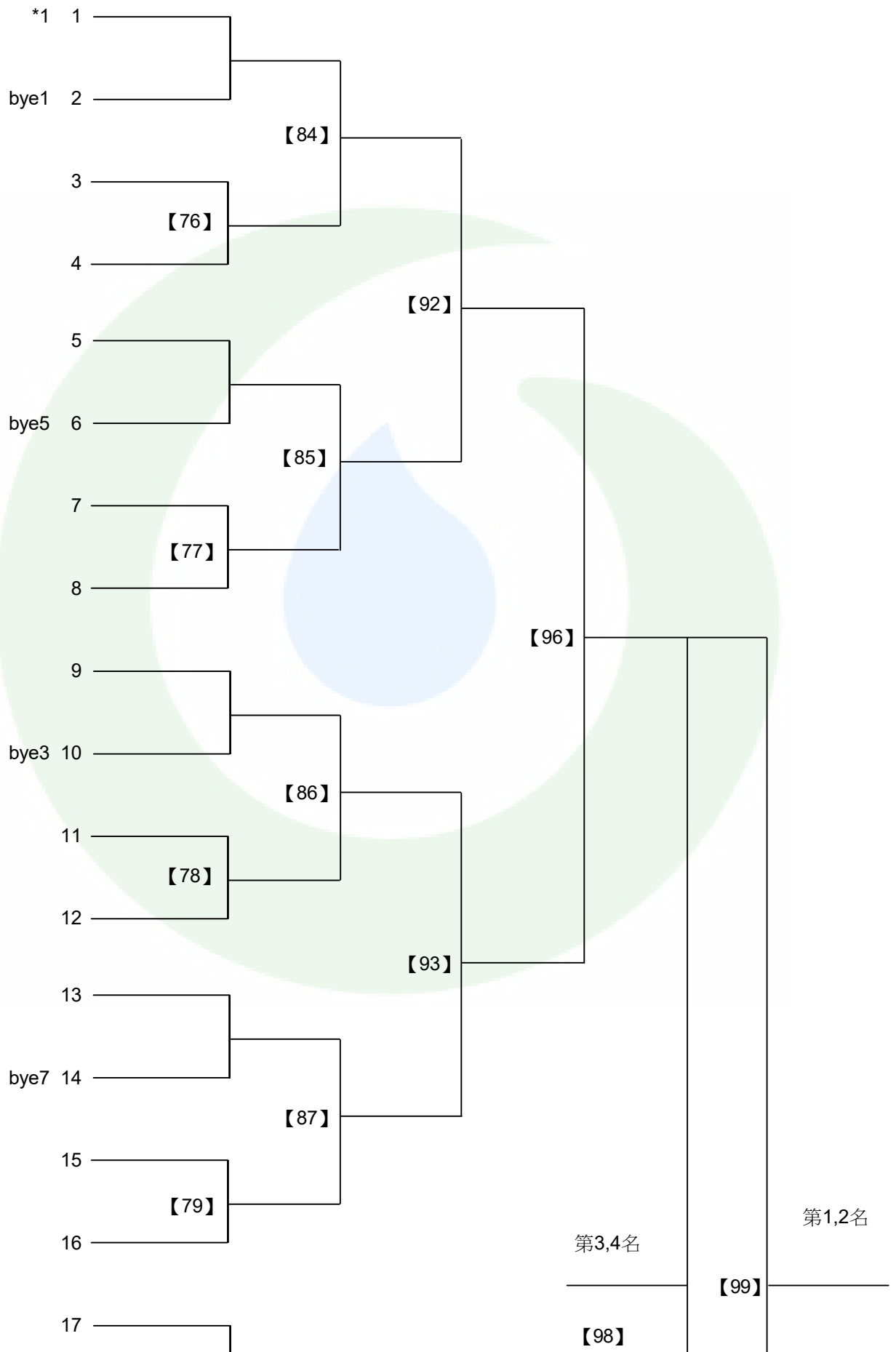

取8名

共21籤

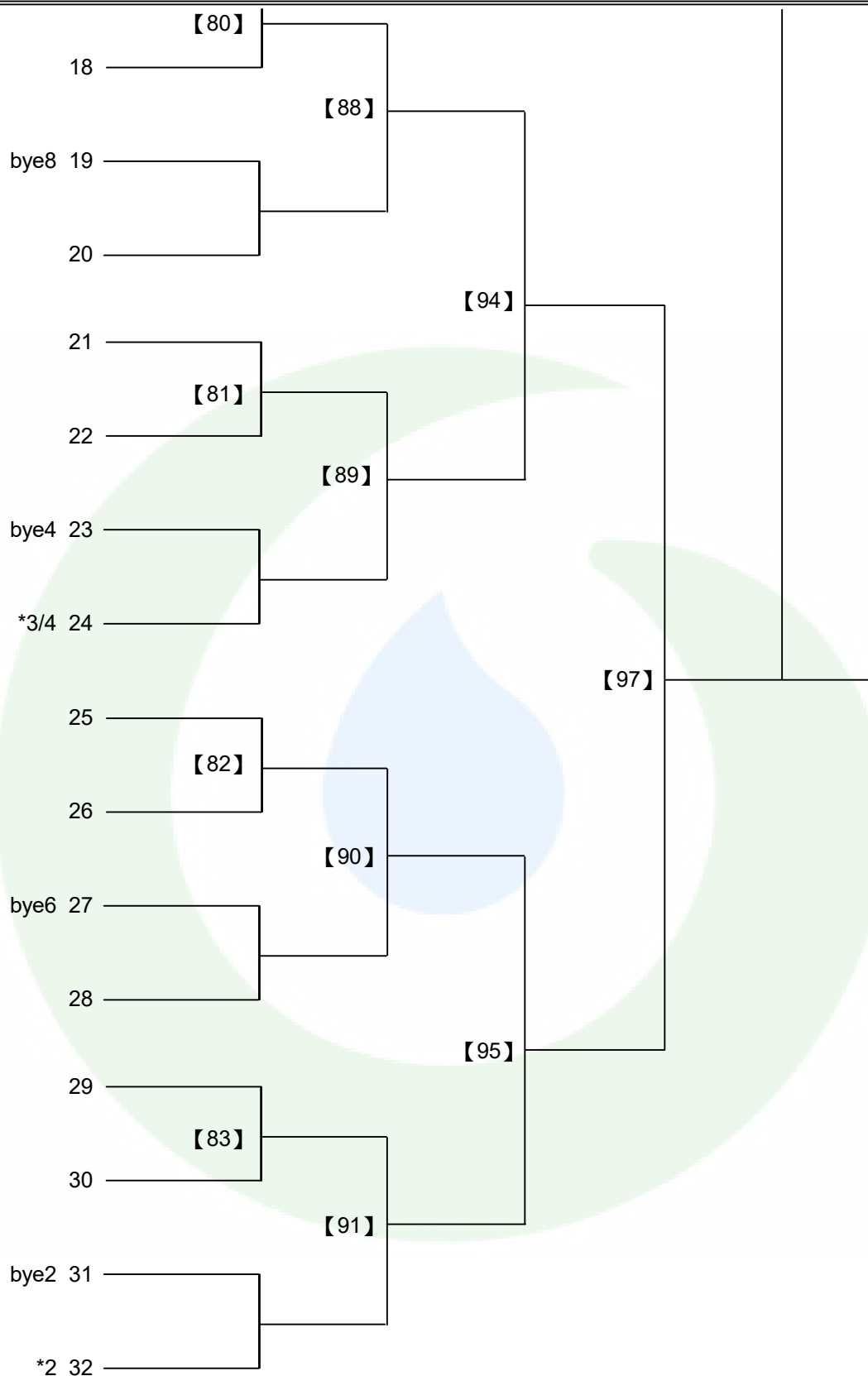

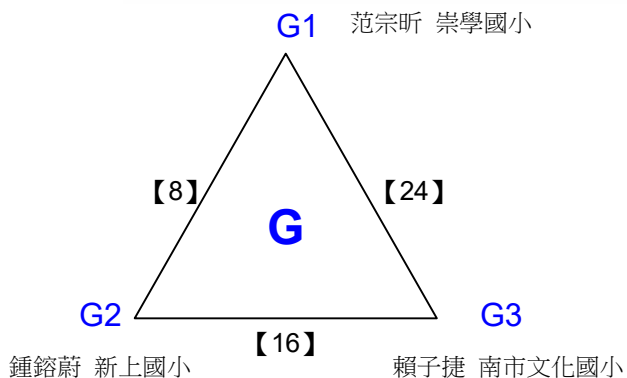
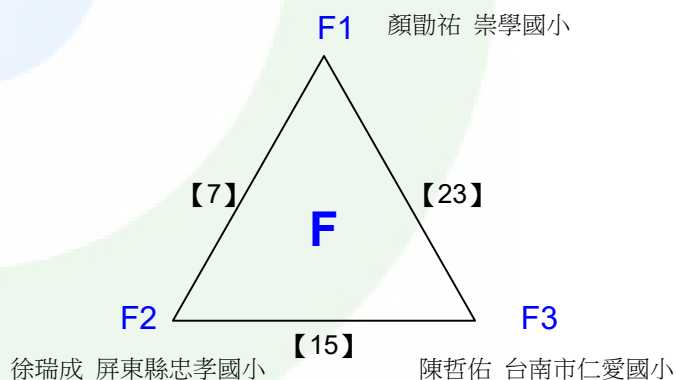
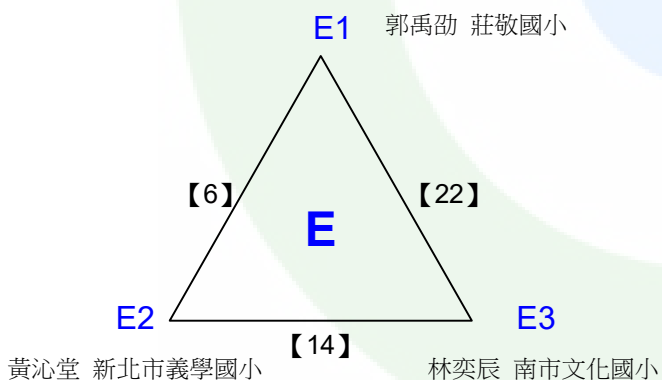
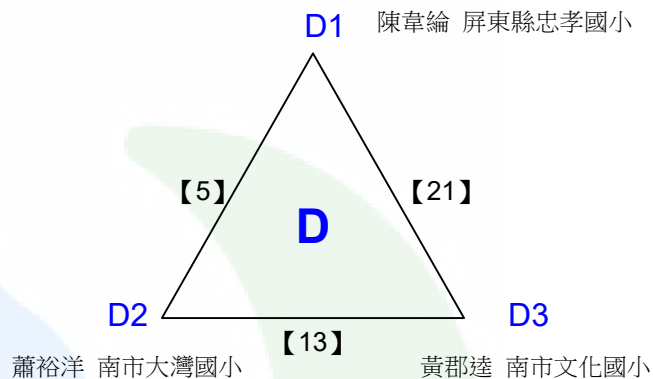
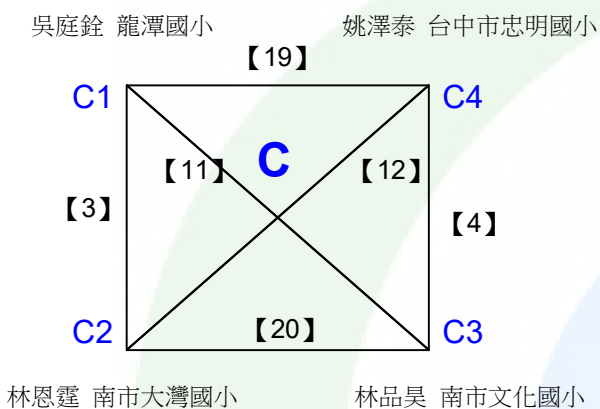
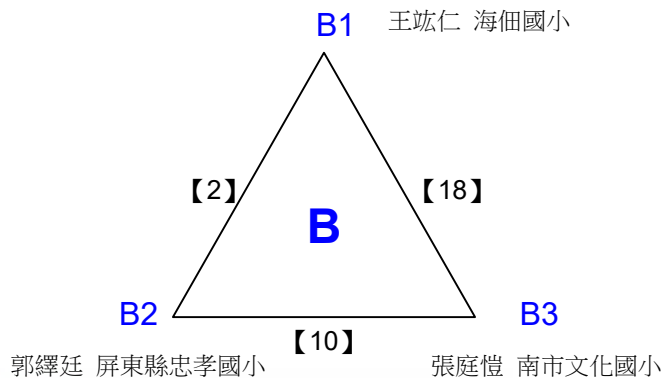
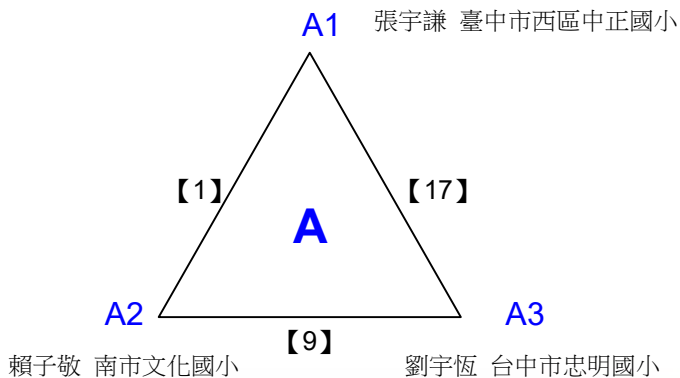

決賽:抽籤決定位置

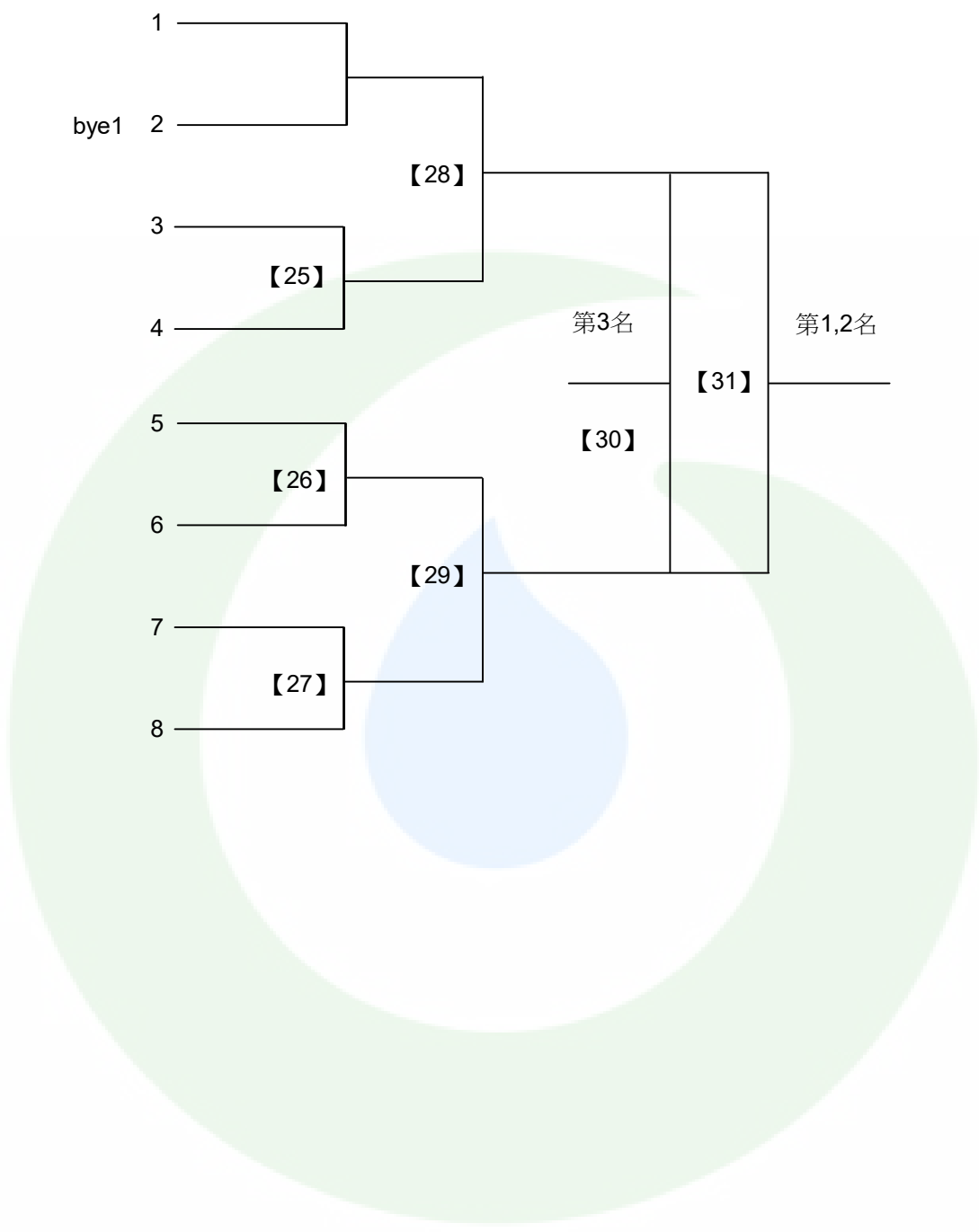

取1名

共6籤

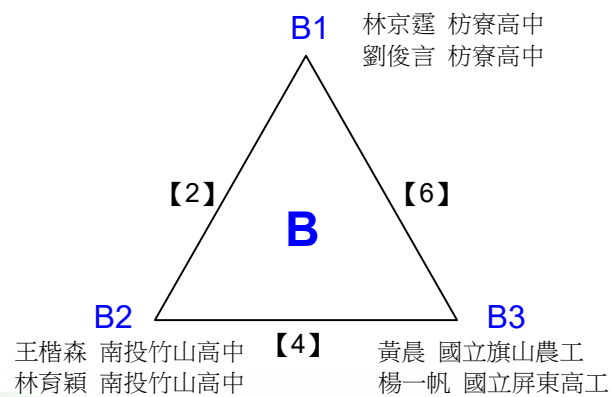
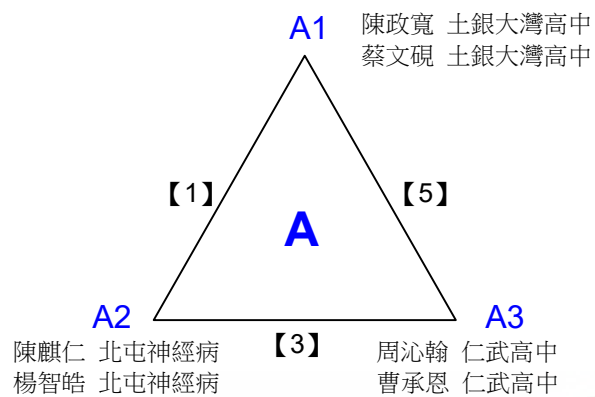

決賽:抽籤決定位置

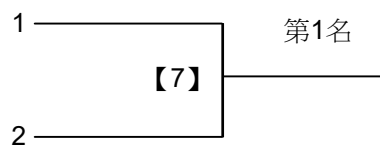

取2名

共10籤

黃永泰 鼎金國中
 程秣堃 鼎金國中

林建曄 土銀大灣高中
 邱金鼎 土銀大灣高中

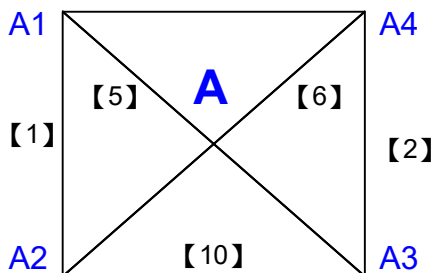

蔣易辰 鳳山高中
 王紹丞 明誠高中

洪子宸 私立有得國中
 洪琮竣 私立有得國中

B1 高崇仁 仁武高中
 杜安達立 仁武高中

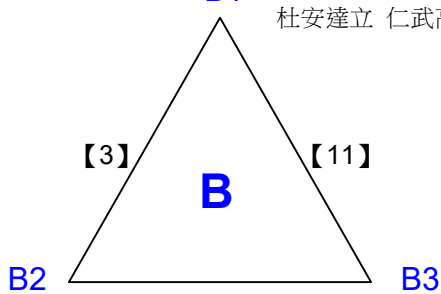

丁永信 鼎金國中
 柯羽禾 鼎金國中

陳政寬 土銀大灣高中
 蔡文硯 土銀大灣高中

C1 許傑森 土銀大灣高中
 蔡知翰 土銀大灣高中

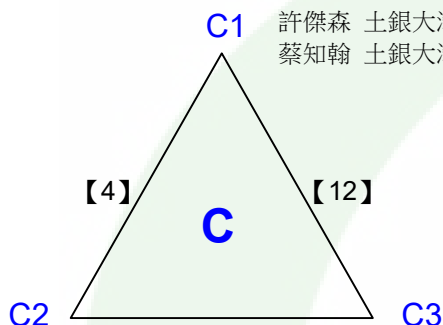

楊孟東 鹽埕國中
 黃傳恩 正興國中

楊喜樂 鼎金國中
 黃俞凱 鼎金國中

決賽:抽籤決定位置

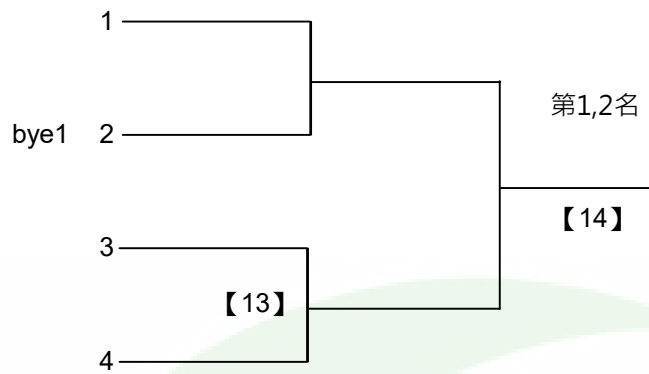

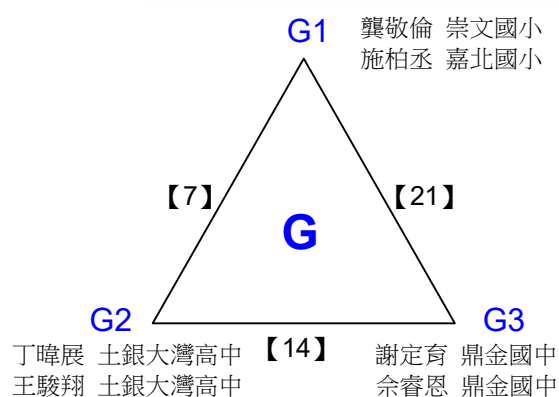
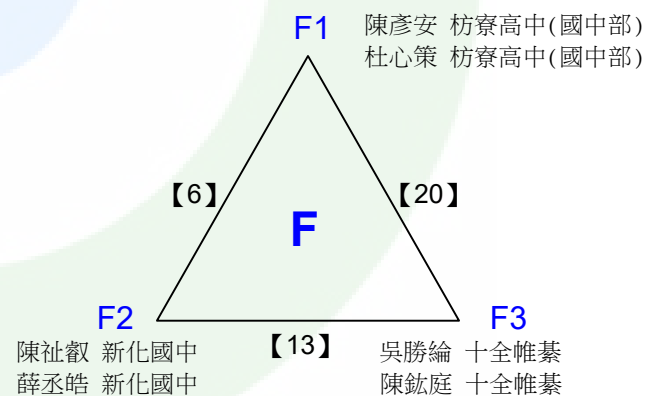
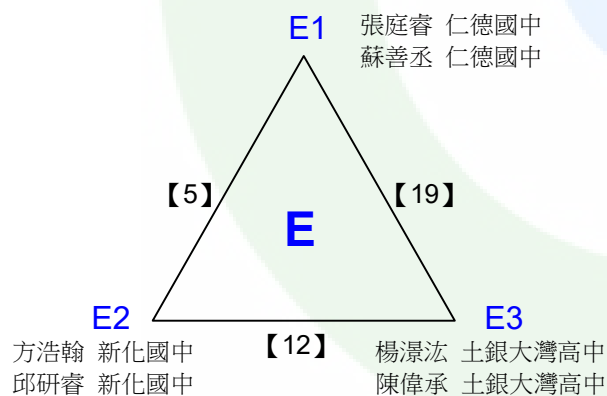
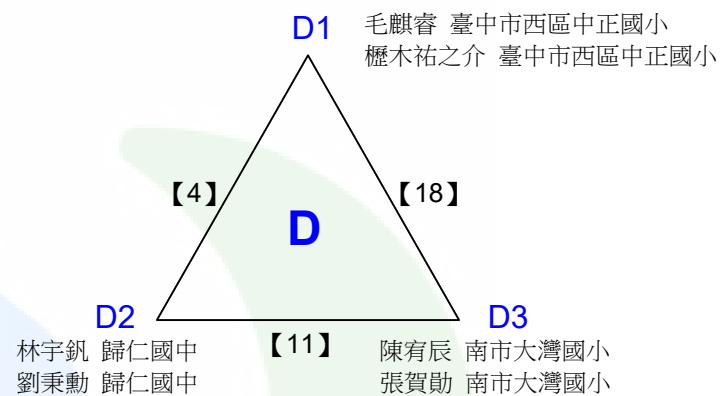
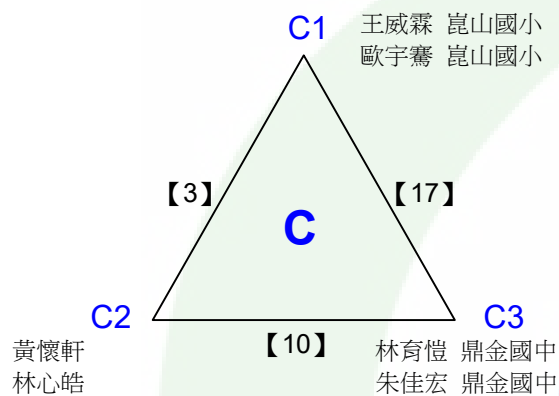
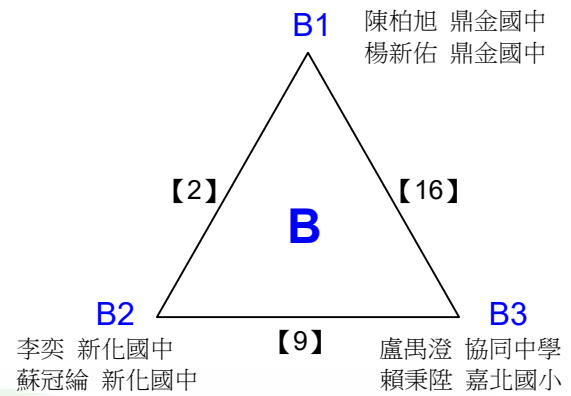
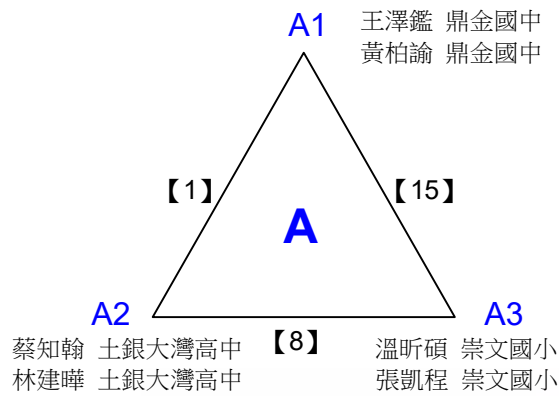

決賽:抽籤決定位置

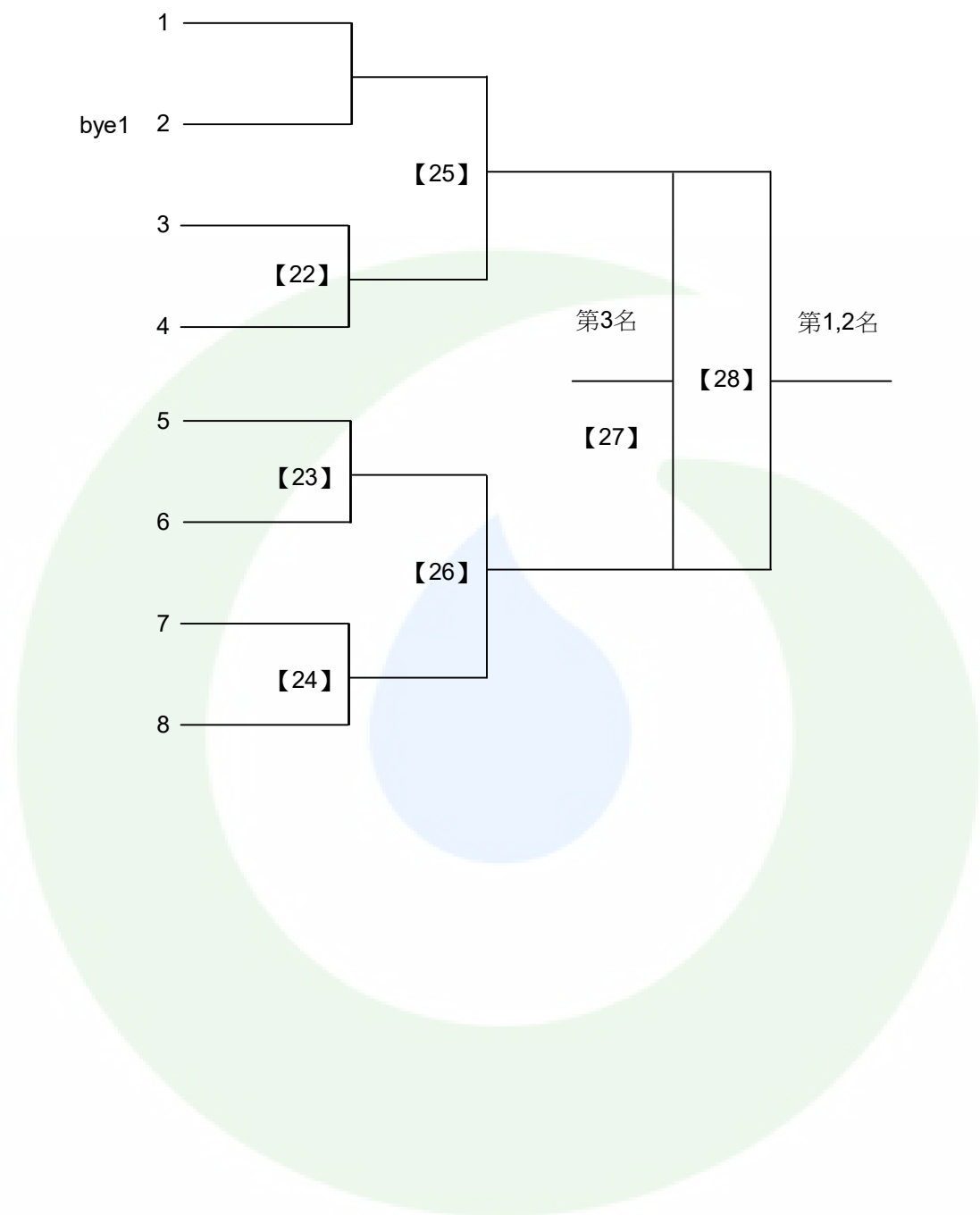

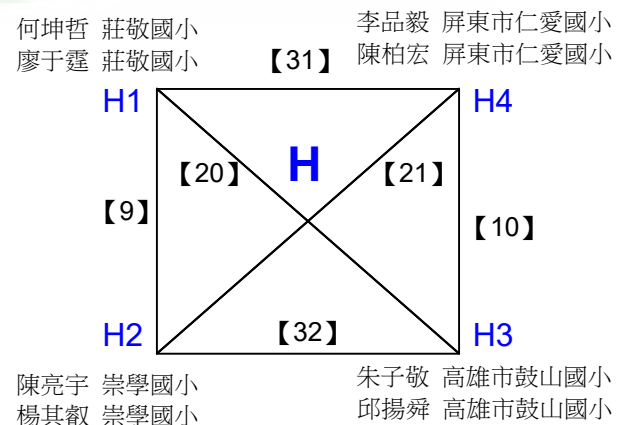
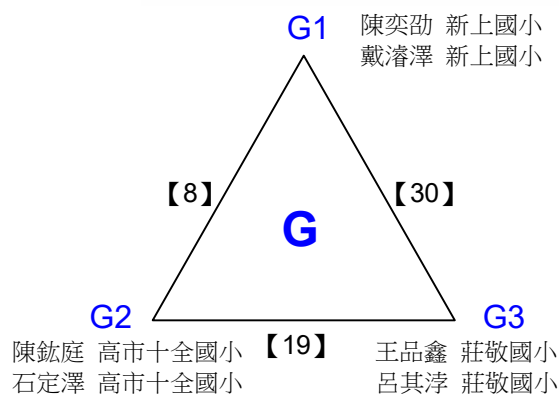
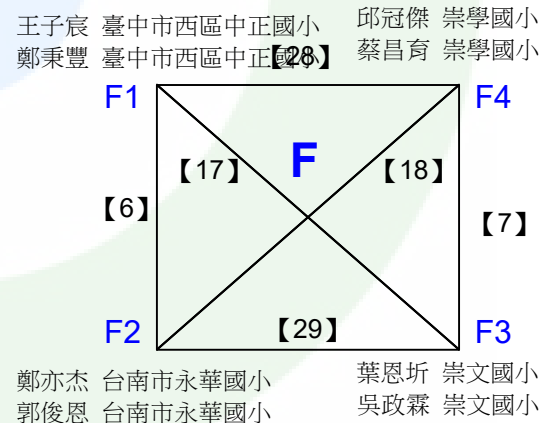
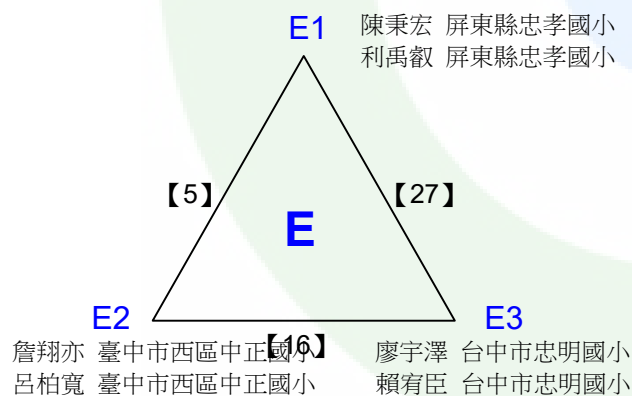
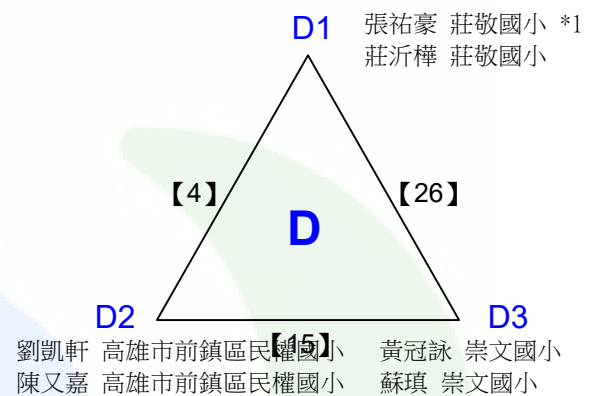
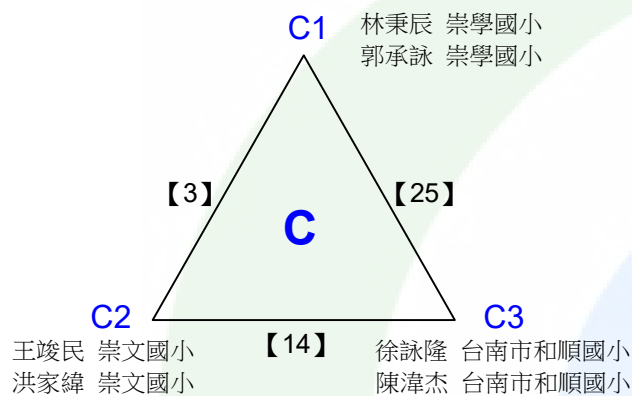
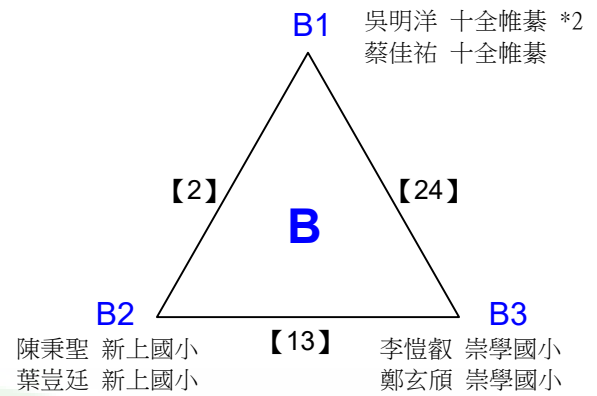
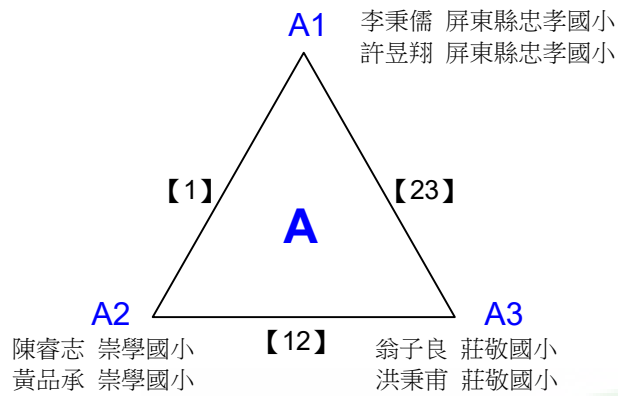

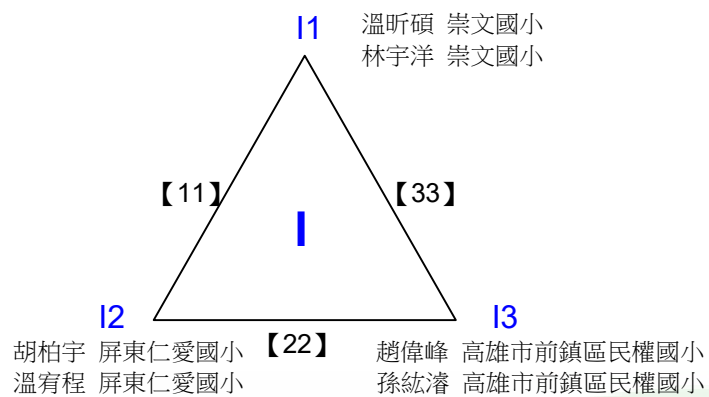

決賽:抽籤決定位置

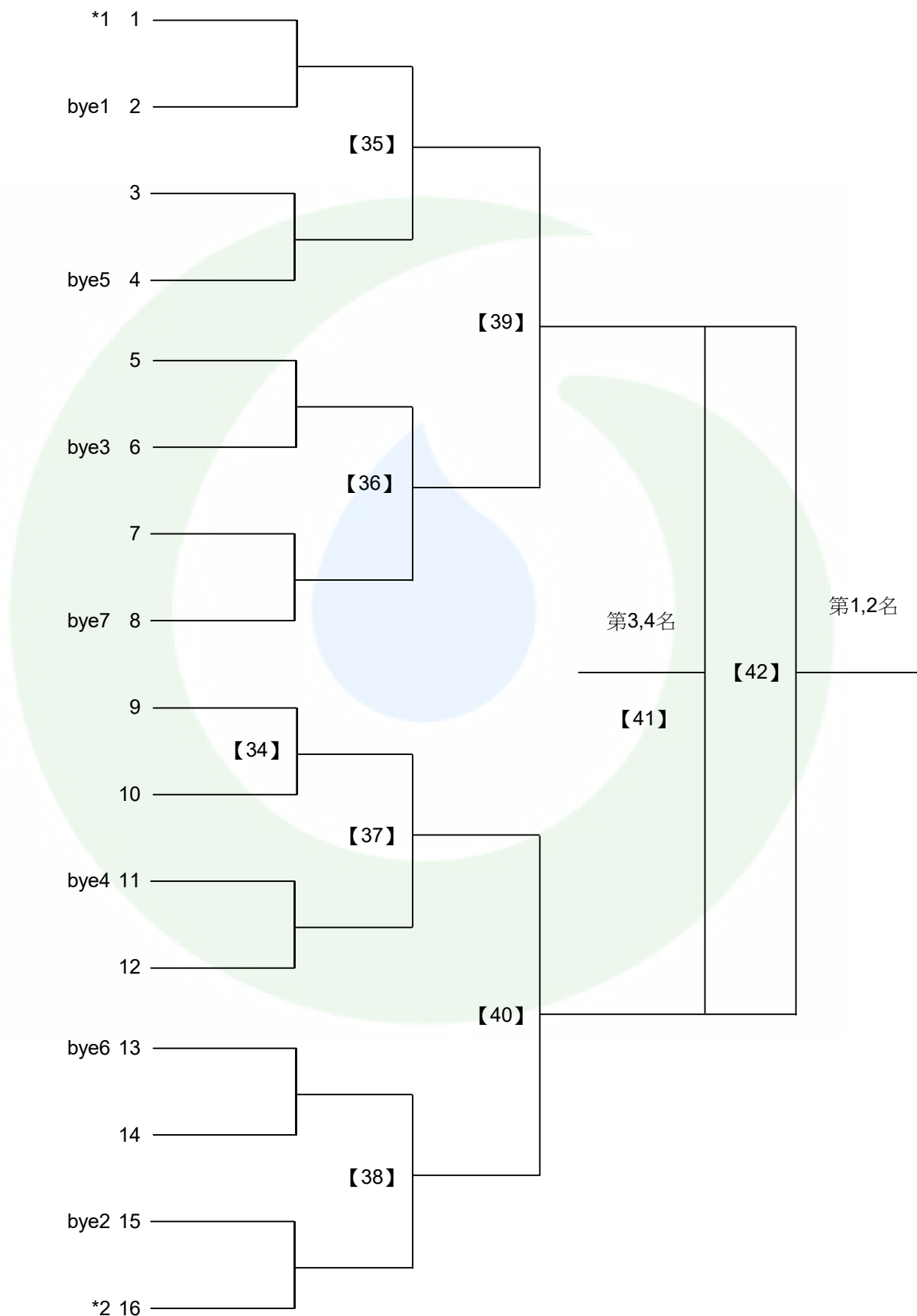

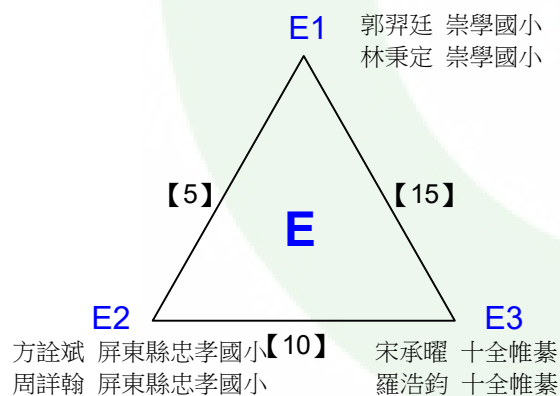
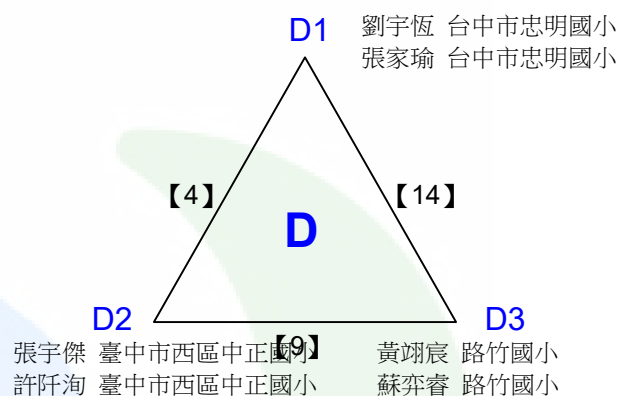
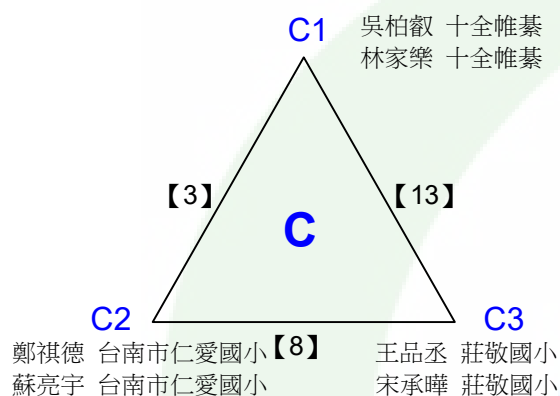
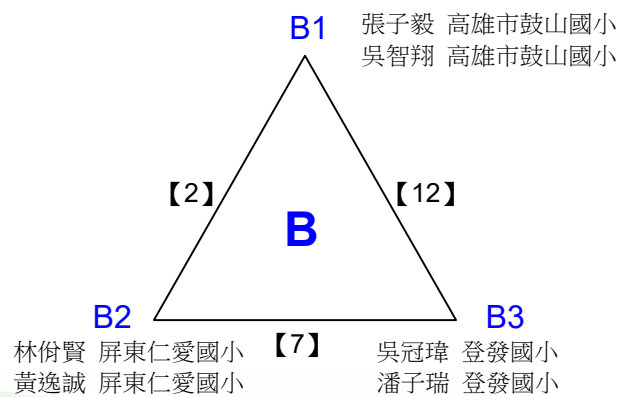
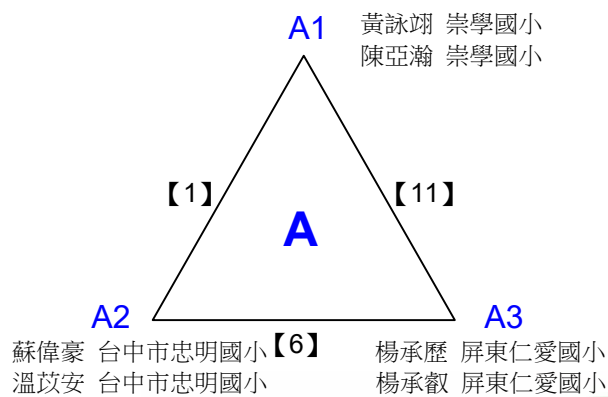

決賽:抽籤決定位置

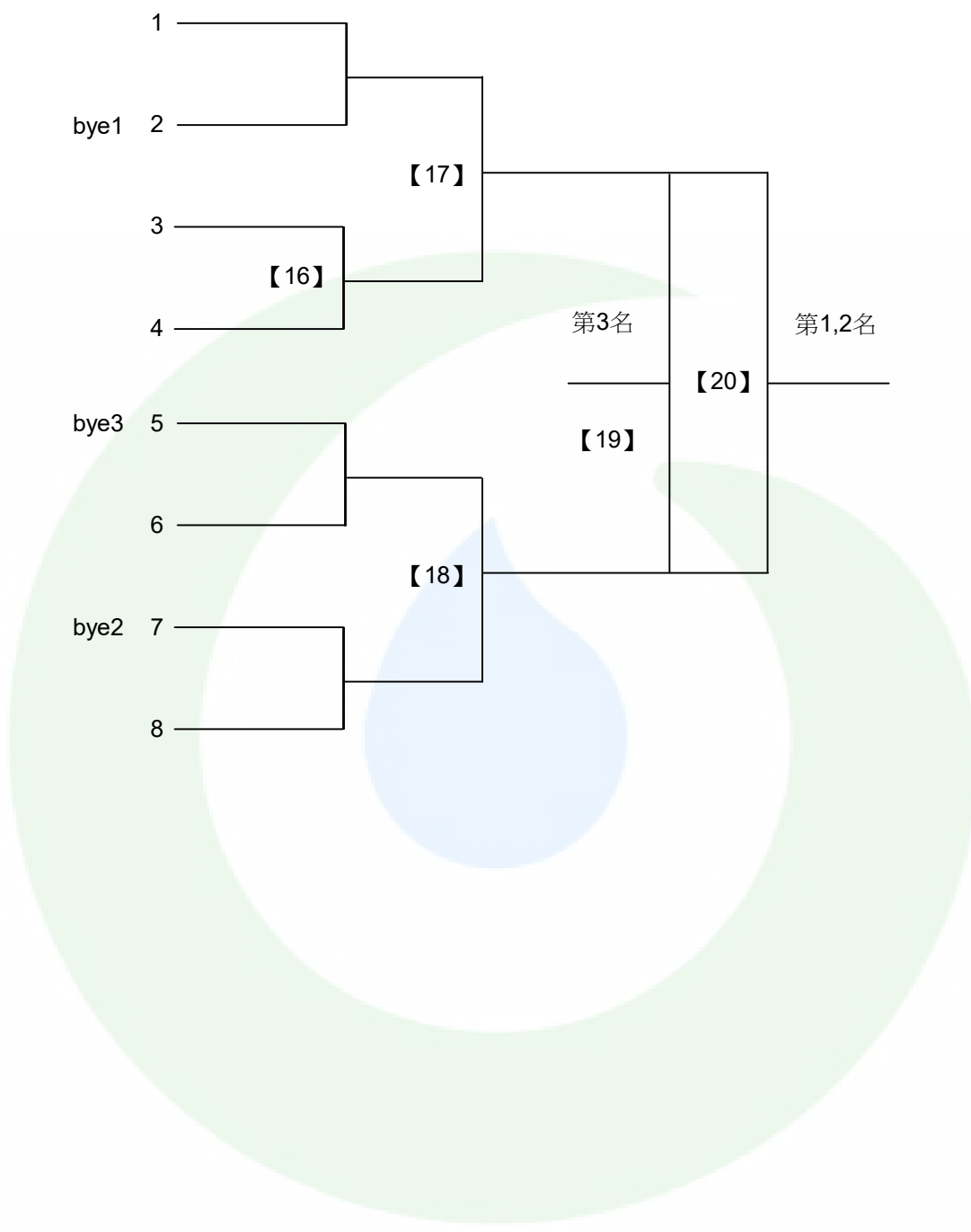

洪郁黎 龍華國中

黃子涵 新興國中

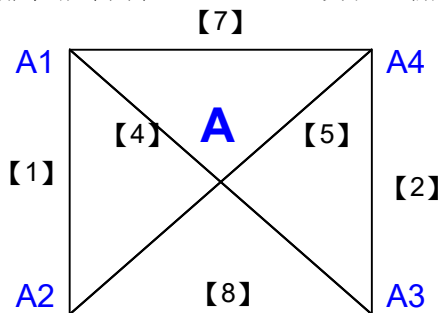

陳沂昀 土銀大灣高中

呂珮煜 竹崎高中

B1 尤茹逸 新化國中

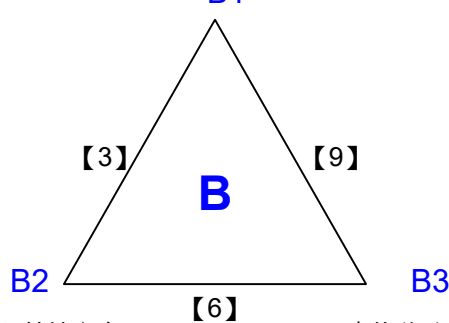

黃榆涵 竹崎高中

史佳璇 新興國中



決賽:抽籤決定位置

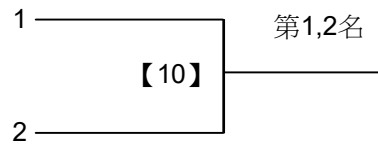

黃安安 滾水燕巢國小 翁苑蔚 亞柏擎天三民

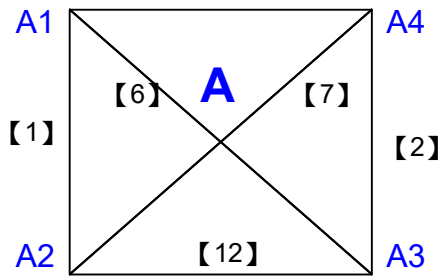

尤茹逸 新化國中 林育詩 永康羽訓

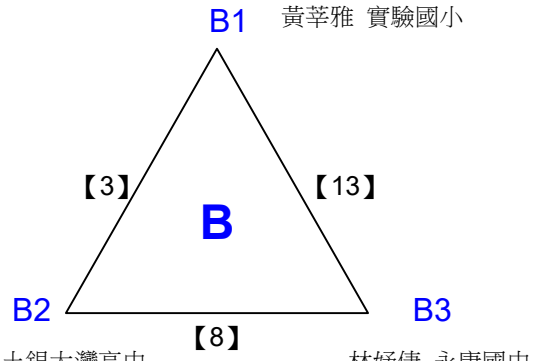

陳祖嘉 土銀大灣高中 林妤婕 永康國中

C1 吳怡萱 十全帷綦

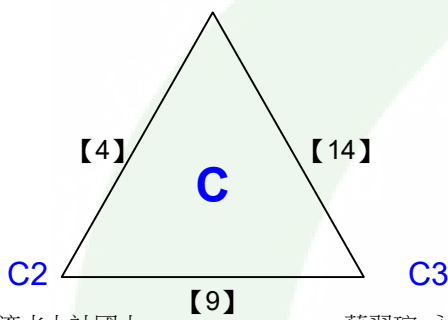

黃羽萱 滾水大社國小 蘇羿瑄 永康國中

D1 詹雯琪 南市文化國小 *1

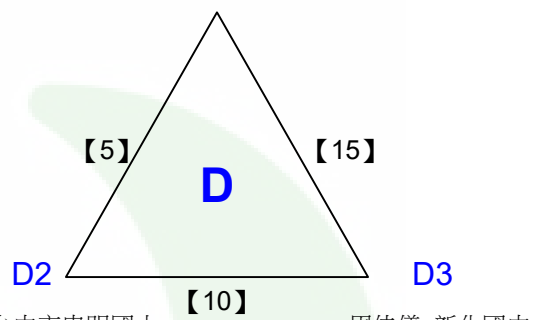

張芷瑜 台中市忠明國小 周佳儀 新化國中

決賽:抽籤決定位置

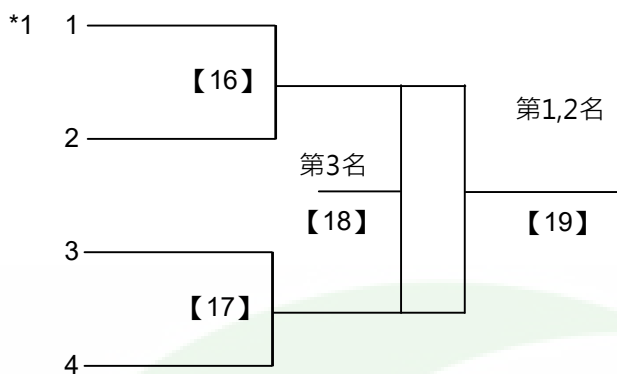

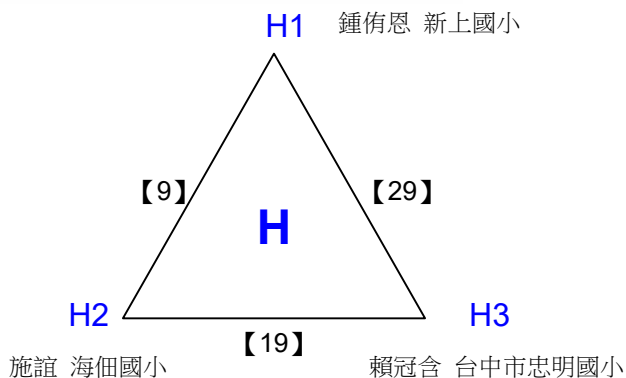
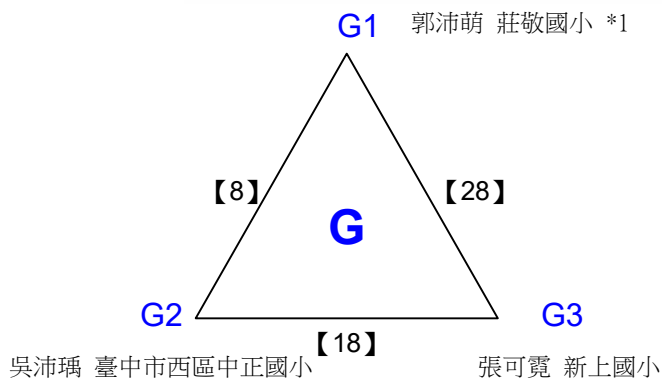
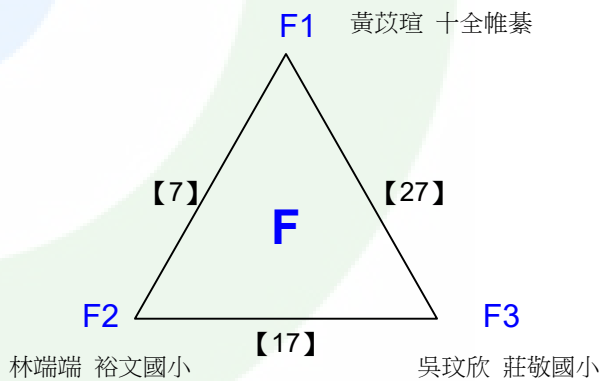
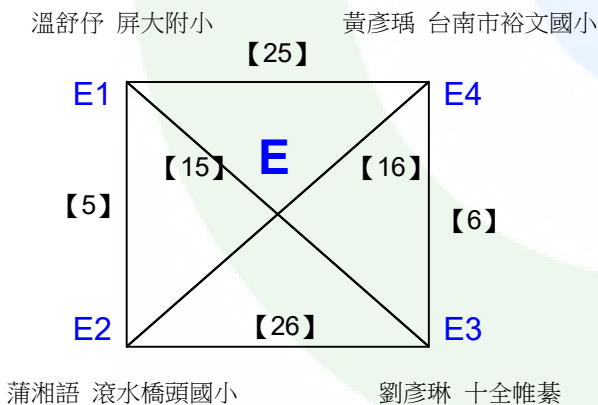
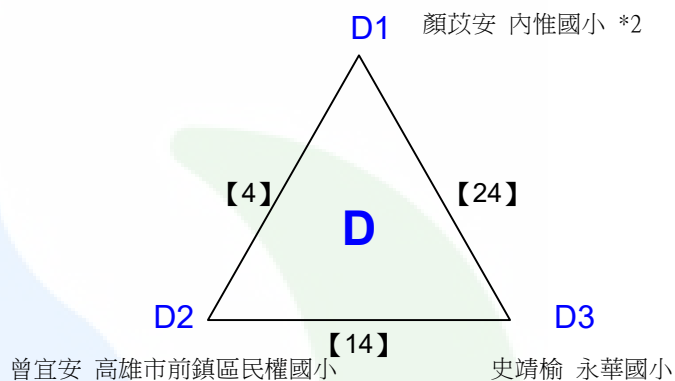
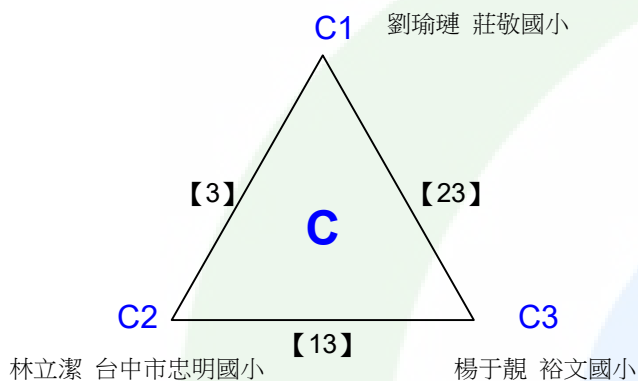
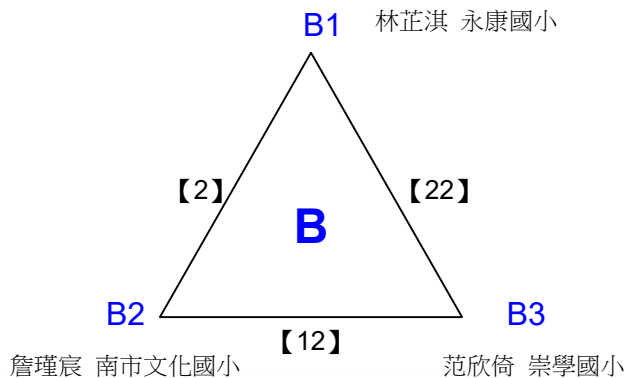
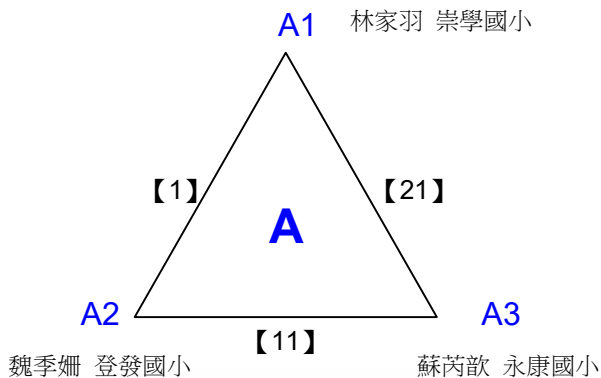

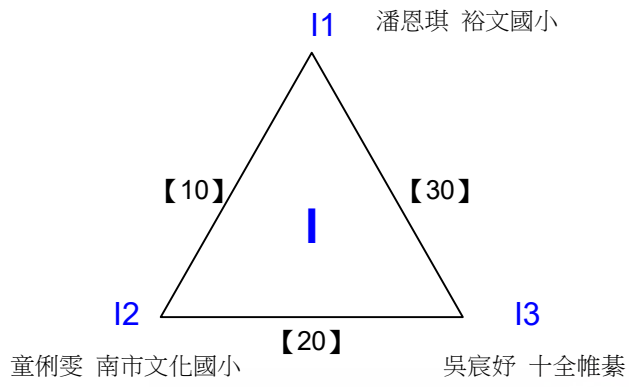

決賽:抽籤決定位置

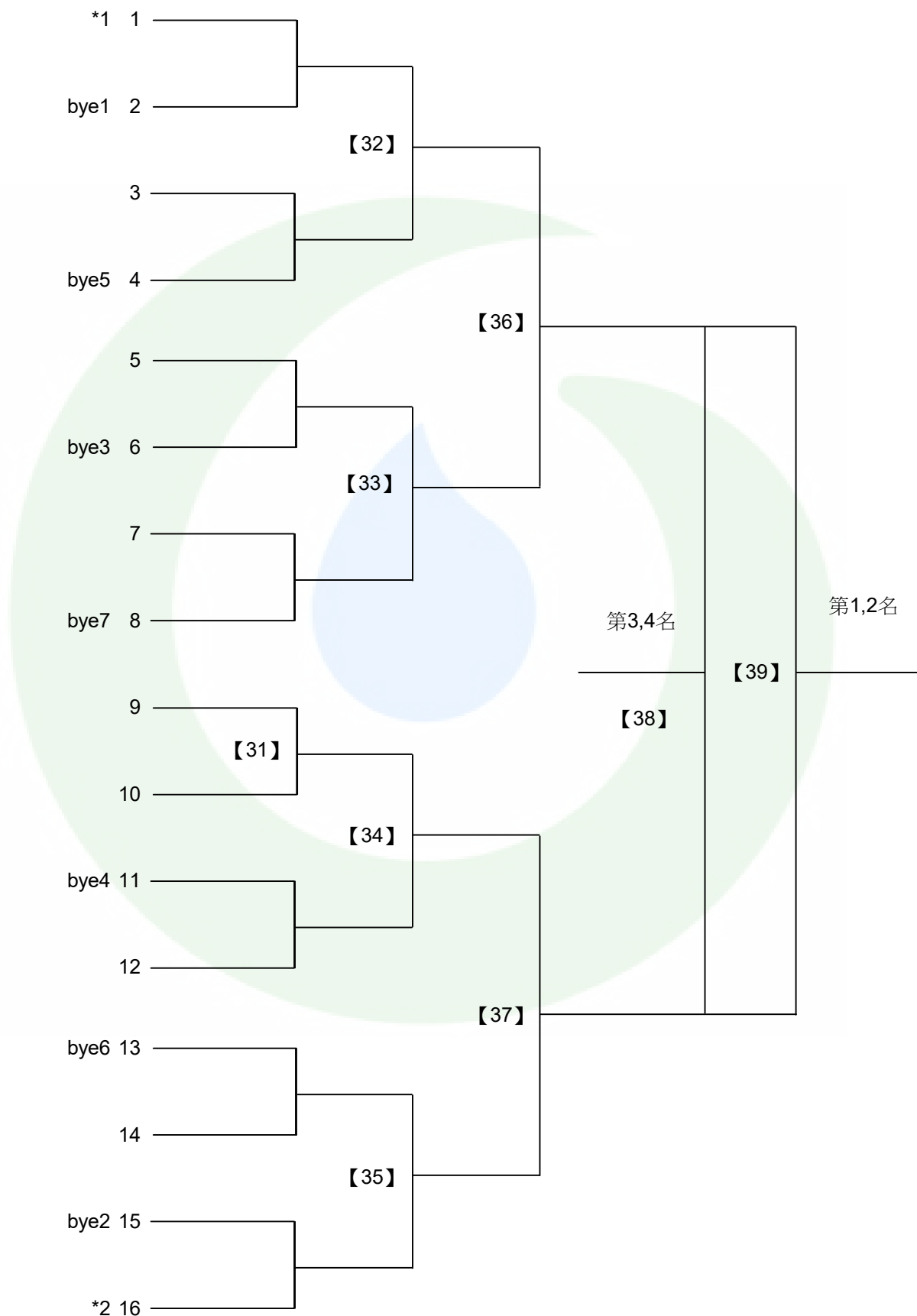

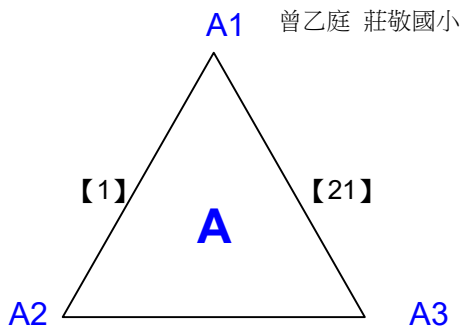

沈可晴 雲縣僑真

蕭云濤 高雄市前鎮區民權國小

石宇娟 高雄市前鎮區民權國小

劉湘翎 崇學國小

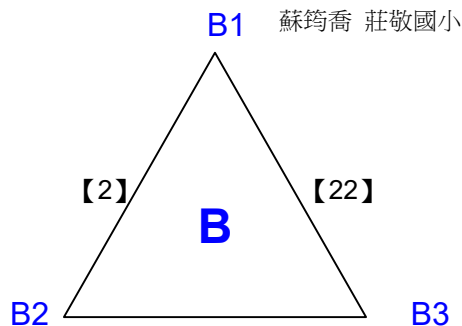

蘇筠喬 莊敬國小

郭珉惟 崇學國小

溫苡安 台中市忠明國小

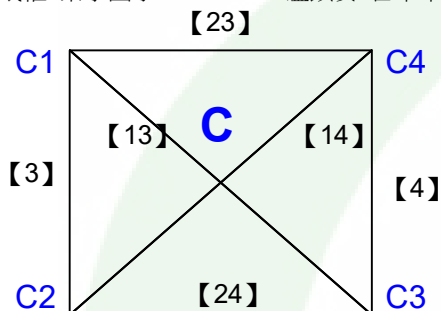

吳羿萱 高雄市前鎮區民權國小

曾筠庭 屏東仁愛國小

李昕穎 滾水油廠國小

范琿敏 崇學國小

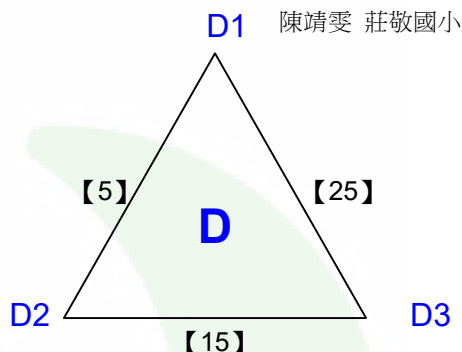

陳靖雯 莊敬國小

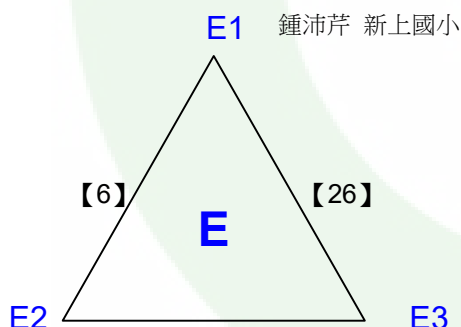

詹詠甯 崇學國小

鐘妍晴 高雄市前鎮區民權國小

林珈仔 南市大灣國小

邱昱禎 崇學國小

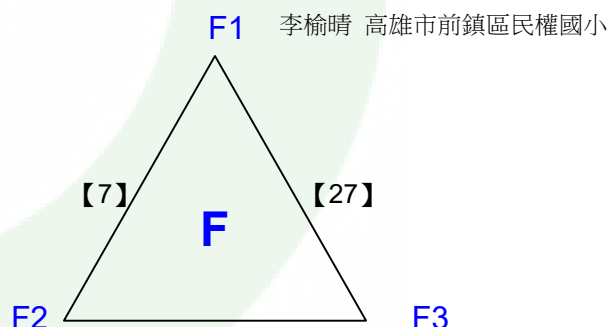

李榆晴 高雄市前鎮區民權國小

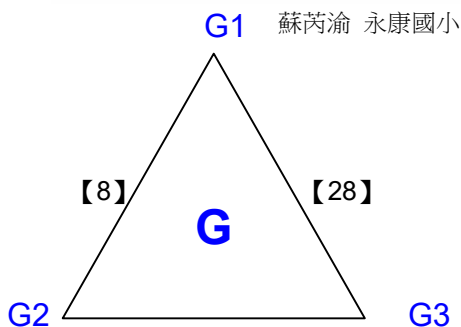

林芷伊 崇學國小

林又安 莊敬國小

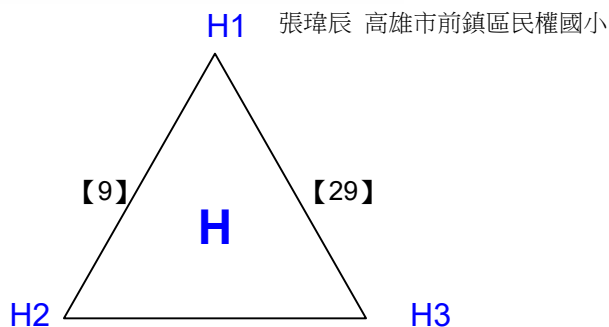

陳佩婷 十全帷蓁

陳彥璇 屏東仁愛國小

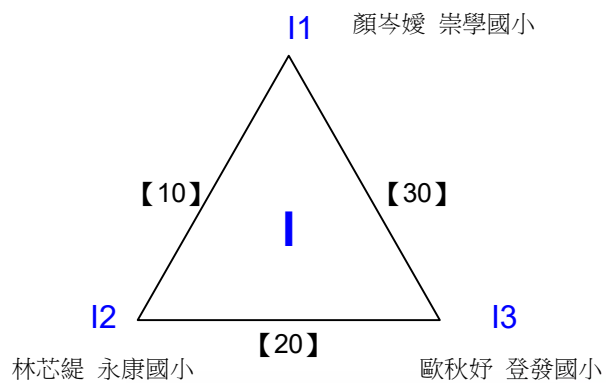

決賽:抽籤決定位置

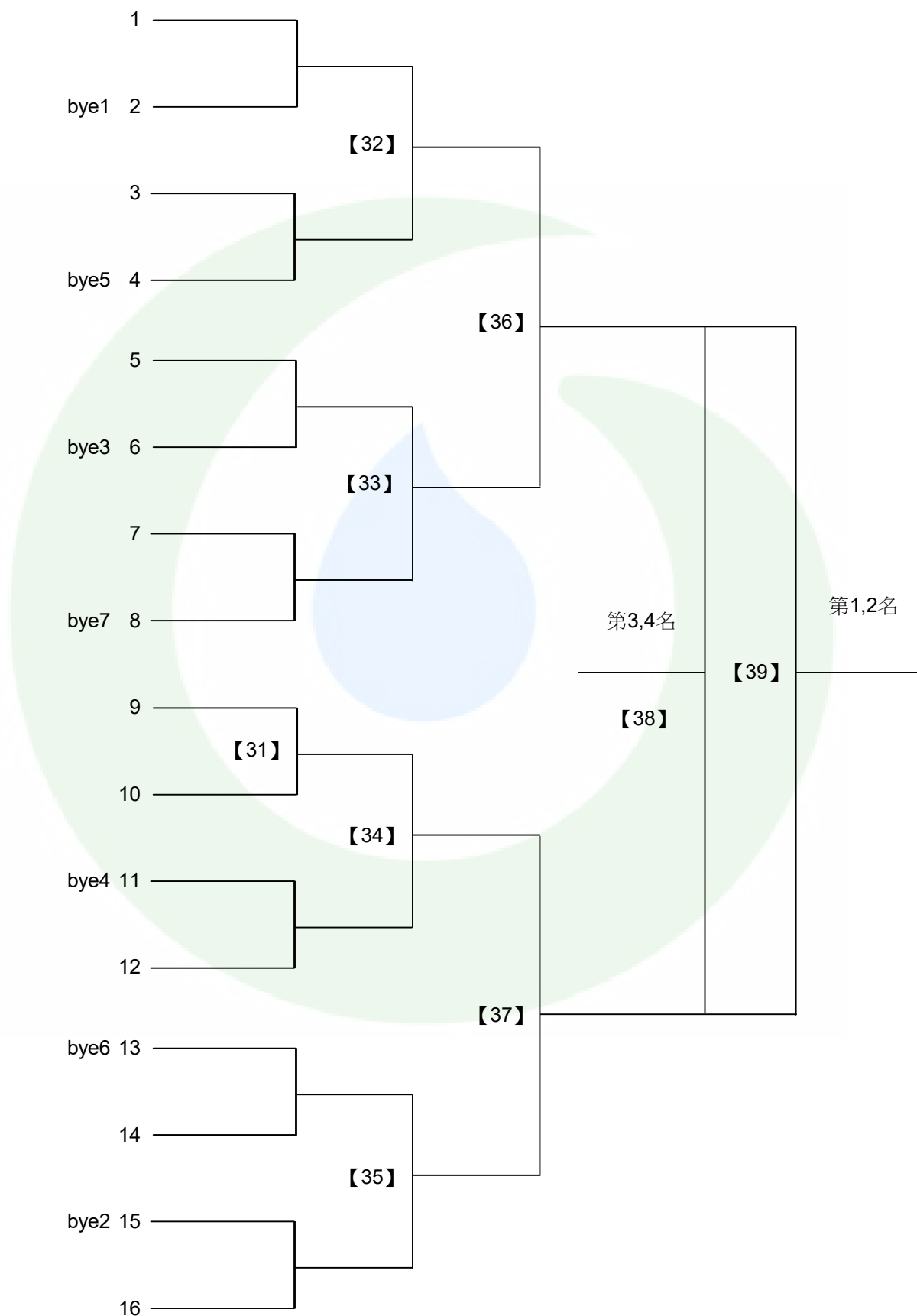

許昱翎 國立屏東大學附設實驗國民小學 陳泯潔 正新國小
【11】

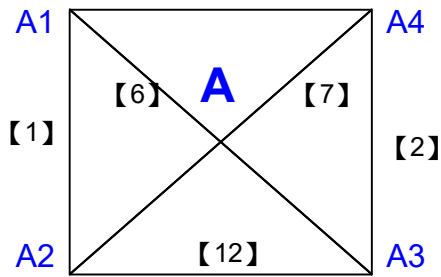

簡妍軒 屏東縣忠孝國小 賴映瑜 台中市忠明國小

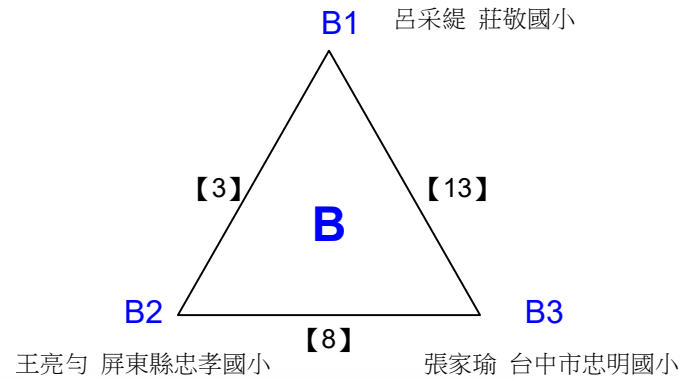

王亮勻 屏東縣忠孝國小 張家瑜 台中市忠明國小

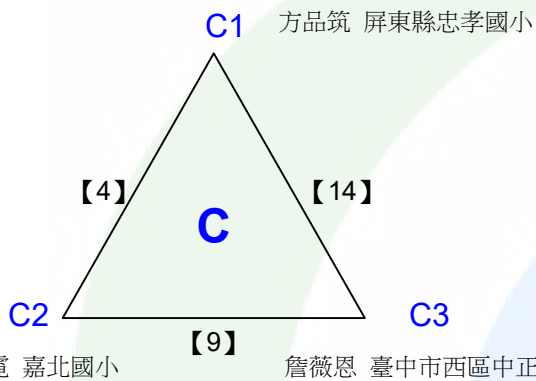

詹昕寬 嘉北國小 詹薇恩 臺中市西區中正國小

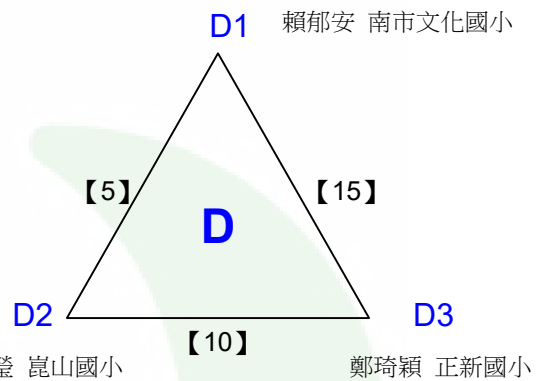

楊于瑩 崑山國小 鄭琦穎 正新國小

決賽:抽籤決定位置

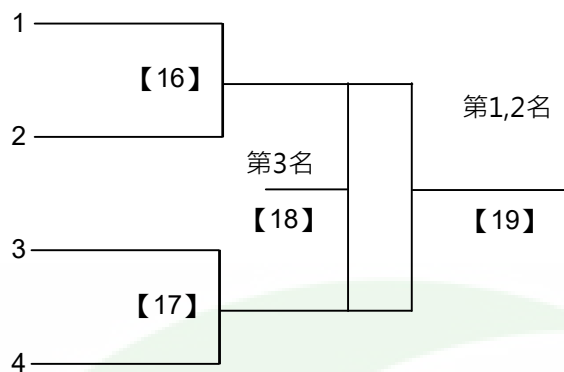

取1名

共4籤

洪好恩 亞柏雄中	黃子涵 新興國中
洪妍恩 亞柏雄中	史佳璇 新興國中

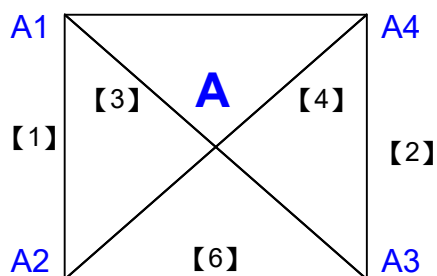

林慧瑀 道明中學	黃榆涵 竹崎高中
鄭安廷 道明中學	呂珮煜 竹崎高中

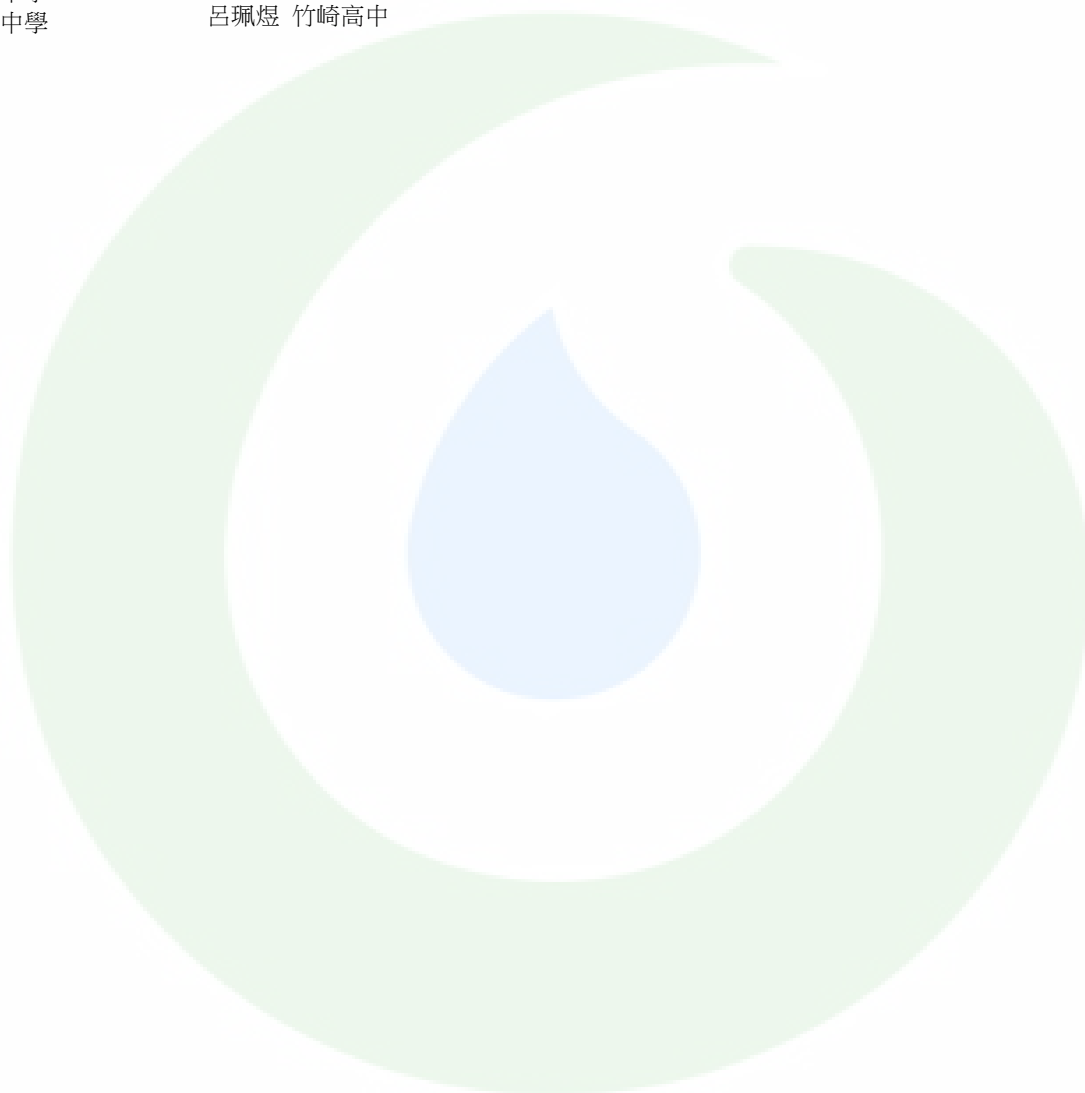

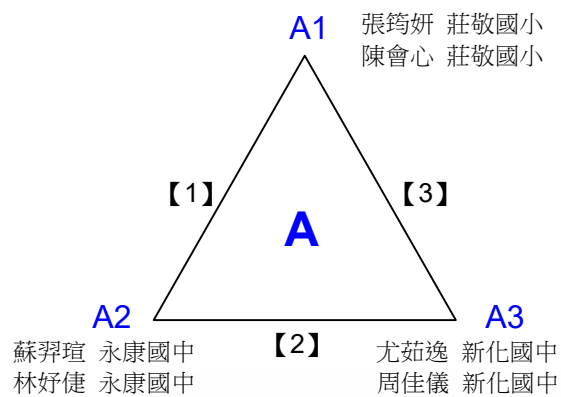

取2名

共7籤

劉瑜璉 莊敬國小
楊亭蕻 莊敬國小

吳宸妤 十全帷綦
劉彥琳 十全帷綦

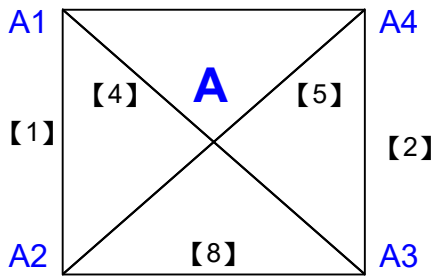

張可寬 新上國小
鍾侑恩 新上國小

林立潔 台中市忠明國小
賴冠含 台中市忠明國小

楊于靚 裕文國小
潘恩琪 裕文國小

詹瑾宸 南市文化國小
董俐雯 南市文化國小

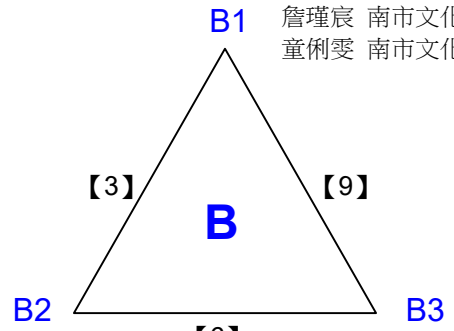

王郁晴 莊敬國小
曾心琳 莊敬國小

